

 **IntesisBox<sup>®</sup> KNX**  
LON

User's Manual  
v10 r15 eng

**Issue date:** 31/08/2012

**© Intesis Software S.L. 2012 All Rights Reserved.**

Information in this document is subject to change without notice. The software described in this document is furnished under a license agreement or nondisclosure agreement. The software may be used only in accordance with the terms of those agreements. No part of this publication may be reproduced, stored in a retrieval system or transmitted in any form or any means electronic or mechanical, including photocopying and recording for any purpose other than the purchaser's personal use without the written permission of Intesis Software S.L.

Intesis Software S.L.  
Milà i Fontanals, 1 bis  
08700 Igualada  
Spain

**TRADEMARKS**

All trademarks and tradenames used in this document are acknowledged to be the copyright of their respective holders.

The information in this document is subject to changes without notice.

Gateway for the integration of LonWorks devices into KNX TP-1 (EIB) control systems.

Different models are available for this gateway, with the following **Order Codes**:

**IBOX-KNX-LON-100**

Model supporting up to 100 internal datapoints and up to 128 LON devices.

**IBOX-KNX-LON-A**

Model supporting up to 500 internal datapoints and up to 128 LON devices.

**IBOX-KNX-LON-B**

Model supporting up to 4000 internal datapoints and up to 128 LON devices.

**INDEX**

1.	Description.....	5
1.1	Introduction .....	5
1.2	Functionality.....	6
1.3	Capacity of IntesisBox .....	7
2.	KNX System .....	8
2.1	Description.....	8
2.2	Points definition .....	9
3.	LON interface of IntesisBox.....	10
3.1	Description.....	10
3.2	Points definition .....	12
4.	Integration of IntesisBox® in ETS .....	13
5.	LinkBoxEIB. Configuration & monitoring tool for intesisBox KNX series .....	14
5.1	Introduction .....	14
5.2	Project definition .....	14
5.3	Connection configuration .....	19
5.4	Signals configuration .....	22
5.4.1	Remember .....	26
5.4.2	Restrictions .....	26
5.5	Saving the configuration and sending it to IntesisBox .....	27
5.6	Signals viewer .....	28
5.7	System commands .....	29
5.8	Files .....	30
6.	Setup process and troubleshooting .....	31
6.1	Pre-requisites .....	31
6.2	Setup procedure .....	31
7.	Connections .....	34
8.	LON interface specifications .....	36
8.1	Supported basic LON data types .....	36
9.	Technical characteristics.....	37
10.	Dimensions .....	38
11.	Annexes .....	39
11.1	Integration of DAIKIN VRV air conditioning systems with KNX.....	39
11.1.1	Using LinkBoxEIB to configure and setup the integration.....	40
11.2	How to setup LonWorks' device address in IntesisBox and how to declare LonWorks devices as commissioned using LinkBoxEIB .....	42

## 1. Description

### 1.1 Introduction

This document describes the integration of KNX TP-1 (EIB) systems LON (TP/FT-10) compatible devices or systems using the gateway *IntesisBox KNX - LON*.

This document assumes that the user is familiar with KNX and LON technology and technical terms.

*From now on, and with the aim of easy the read of this document, just the word "IntesisBox" will be used instead of the full gateway model description "IntesisBox KNX - LON".*

The aim of this integration is to make accessible signals and resources of any LON based system or device (for example Daikin VRV AC system) from any KNX TP-1 (EIB) control system.

For this, IntesisBox acts as a LON client device in its LON interface, reading/writing points of other LON device(s), and offering this point's values of LON device(s) through its KNX interface, acting in the KNX system as one more KNX device of the system. The readings of the LON device(s) are performed by IntesisBox by continuous polling.

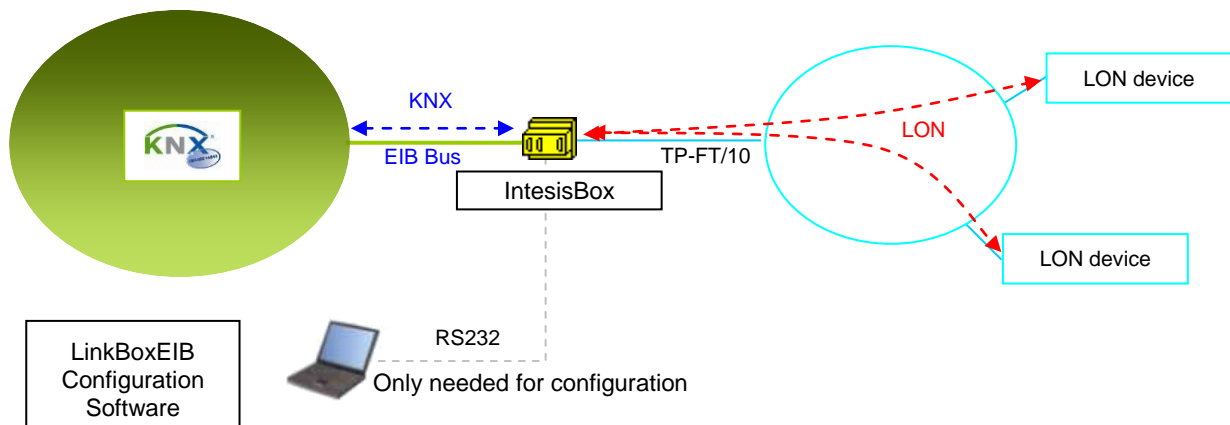

### Integration of LON and KNX using *IntesisBox KNX - LON* gateway

## 1.2 Functionality

The integration operation is as follow:

From the LON system point of view, after the start up process, IntesisBox reads continuously the points configured to be read by polling into the LON devices, and updates in its memory all the values received.

Every one of the mentioned points of the LON devices is associated to a *KNX group address*, with this, all the LON system is seen as *one more KNX device* from the KNX system point of view, with the same configuration and operation characteristics.

When a change in any point (of type output or input/output) in the LON device is detected during the polling process, a write telegram is sent immediately to the KNX bus, of the associated *KNX Group*, to inform the KNX system about the new value.

When a telegram is received from the KNX bus, of a *KNX Group address* associated to a LON point, a message is sent immediately to the corresponding LON device to perform the corresponding action.

In the continuous polling of the LON devices, if a non response of any LON device is detected, the corresponding virtual signal inside IntesisBox will be activated indicating communication error with that LON device. These virtual signals indicating communication status in real time with the LON devices are also accessible from KNX, like the rest of the points of IntesisBox. *A special virtual signal indicating the correct operation of the LON interface handler inside the IntesisBox is also available from KNX.*

### 1.3 Capacity of IntesisBox

Element	100 version	A version	B version	Notes
Type of LON devices				Those supporting <i>Twisted Pair - Free Topology</i> channel (TP/FT-10)
Supported number of network variable fields	100	500	4000	Maximum number of points (KNX group addresses) that can be defined into IntesisBox. Each of them can contain an individual field from a network variable.
Supported number of LON devices	128	128	128	Maximum number of different LON devices that can be defined into IntesisBox (to read/write points into them).

There are three different models of *IntesisBox® KNX - LON* with different capacity each one of them.

- 100 model, allowing to integrate up to 100 points and 128 devices.  
*Ref.: IBOX-KNX-LON-100*
- A model, allowing integrating up to 500 points and 128 devices.  
*Ref.: IBOX-KNX-LON-A*
- B model, allowing integrating up to 4000 points and 128 devices.  
*Ref.: IBOX-KNX-LON-B*

## 2. KNX System

In this section, a common description for all IntesisBox KNX series gateways is given, from the point of view of KNX system which is called from now on *internal system*. The LON system is also called from now on *external system*.

### 2.1 Description

IntesisBox KNX connects directly to the KNX TP-1 (EIB) bus and behaves as one more devices into the KNX system, with the same configuration and operational characteristics as other KNX devices.

Internally, the circuit part connected to the KNX bus is opto-isolated from the rest of the electronics.

IntesisBox KNX receives, manages and sends all the telegrams related to its configuration to the KNX bus.

On receiving telegrams of KNX Groups associated to the external system (LON in this case), the corresponding messages are sent to the external system to maintain both systems synchronised in every moment.

When a change in a signal of the external system is detected, a telegram is sent to the KNX bus (of the associated KNX group) to maintain both systems synchronised in every moment.

The status of the KNX bus is checked continuously and, if a bus drop down is detected, due to a failure in the bus power supply for example, when the KNX bus is restored again, IntesisBox will retransmit the status of all the KNX groups marked as "*T*" *Transmit*. Also the *Updates* of the groups marked as "*U*" *Update* will be performed. The behaviour of IntesisBox for every point is determined by the flags configured individually per every point.



## 2.2 Points definition

Every signal of the external system (LON) to use has the following KNX properties:

Property	Description
<b>Description</b>	Signal's Description. Only for informative purposes, allows identifying the signal comfortably.
<b>EIS</b> (DataPoint)	It's the KNX data type used to code the signal's value. It will depend on the type of signal associated in the external system in every case. In some integration it is selectable, in others it is fixed due to the intrinsic characteristics of the signal.
<b>Group</b>	It's the KNX group to which the signal is associated. It is also the group to which the read (R), write (W), transmit (T) and update (U) flags are applied. Is the sending group.
<b>Listening addresses</b>	They are the addresses that will actuate on the signal, apart of the Group address.
<b>R</b>	Read flag. If activated, read telegrams of this group will be allowed.
<b>W</b>	Write flag. If activated, write telegrams of this group will be allowed.
<b>T</b>	Transmit flag. If activated, when the signal's value changes, due to a change in the external system, a write telegram of the group will be sent to the KNX bus.
<b>U</b>	Update flag. If activated, on IntesisBox start-up or after a KNX bus reset detection, read telegrams of the sending group will be sent to the KNX bus, and the value received will be sent to the external system as if it has been received by a write telegram.
<b>Active</b>	If activated, the signal will be active in IntesisBox, if not, the behaviour will be as if the signal is not defined. Allows deactivating signals without the need of delete them for possible future use.

These properties are common for all IntesisBox KNX series gateways, although for every integration may have specific properties according to the type of signals of the external system in every case.

## 3. LON interface of IntesisBox

### 3.1 Description

The LON systems are composed of devices connected to a network, the media and topology of the bus used to interconnect the different devices in the network can be of some different types, even devices connected to different media can coexist and communicate between them in the same LON network by the use of media converters (switches, routers...).

IntesisBox LON interface is compatible with *twisted pair free topology channel* (TP/FT-10) media, nowadays the most widely used media due to its robustness and the different topologies that can be used and mixed together.

All LON devices offer their internal datapoints (of input and output type) in the form of standardised data objects called *Standard Network Variable Types* (SNVTs), which assures total interoperability between LON devices. More specific data types used basically for configuration purposes of the LON devices are also defined by the standard (SCPTs), and even user defined data types (UNVT) can be implemented and used by any manufacturer in a LON device.

All the mentioned data types are also supported by IntesisBox.

Standard Network Variable Types (SNVTs) are named by convention with a prefix that indicates if it is an input variable (prefix *nvi*) or an output variable (prefix *nvo*).

A SNVT can be composed of one or more data fields, for example, one of the most used SNVTs is the type *switching*, this SNVT has two data fields: *value*, and *state*.

Many devices use this SNVT *switching* for basic ON/OFF operations, and for the device to accept a given operation (ON or OFF) you must write specific values in the field *state* but also in the field *value* at the same time. For example, when communicating with the Daikin LON interface DMS504B51, to switch ON the AC indoor unit number 1, you have to use the variable *nviOnOff\_01* (of type *switching*), and the values to write in both fields can be the following:

<b>Operation</b>	<b>Value</b>	<b>State</b>
ON	1 - 255	1
OFF	0	1
OFF	Any (0 - 255)	0

Note that you must write into both fields of the variable to accomplish both operations, ON and OFF. This can be a great inconvenience to be done from systems like KNX in which just an object of type *switching* (one single value is sent) is used for this kind of operations.

To solve this, special SNVT with filters have been incorporated to IntesisBox, using these special SNVTs with filters you can write into more than one field of the LON variable when you write just a single value from KNX. See below an example of use of a special SNVT with filter called *SNVT\_switch\_filter\_0\_1* linked to the mentioned above variable *nviOnOff\_01* of Daikin.

<b>Operation</b>	<b>KNX</b>	<b>SNVT_switch_filter_0_1</b>	<b>nviOnOff_0_1 Value</b>	<b>nviOnOff_0_1 State</b>
OFF	0	0	0	0
ON	1	1	100	1

This way you only have to choose the right special SNVT with filter into the IntesisBox configuration table for this kind of LON variable and associate it to an individual KNX group address (of an standard EIS type).

See below in this document the list of special SNVTs with filters available in IntesisBox.

### 3.2 Points definition

Every point defined into IntesisBox has the following LON features associated to it:

Feature	Description
<b>Device</b>	<p>LON device to which belongs the point, from a list of LON devices that can be defined into IntesisBox (up to 128).</p> <p>For each LON device defined, a virtual signal is created automatically in IntesisBox to inform about the communication with the LON device, this signal is available also from the KNX interface like the rest of the points.</p>
<b>SNVT</b>	SNVT number according to EIA-709 standard.
<b>SNVT Name</b>	SNVT Name, selectable from the list of all available SNVTs defined by EIA-709 standard, and also special SNVTs with filters explained above.
<b>Idx</b>	Index of the network variable inside the LON device.
<b>RW</b>	<p>Indicates if the variable is of type input (W), output (R), or input/output (RW).</p> <p><i>Note that an output variable in the LON device must be defined as R, to be read by the IntesisBox. And an input variable as W, to be written by the IntesisBox.</i></p>

## 4. Integration of IntesisBox® in ETS

As explained in previous section the IntesisBox® is configured with the LinkBoxEIB but in some projects it might be needed to integrate the gateway in the ETS project, for example to allow the line couplers have a correct configuration of their filter tables. To do so a Dummy device can be used in ETS to simulate the IntesisBox and associate also to this dummy device all group addresses used in IntesisBox

In [http://www.intesis.com/down/eib/Dummy\\_Intesis.zip](http://www.intesis.com/down/eib/Dummy_Intesis.zip) an ETS project containing a Dummy device can be downloaded for this purpose. To use it with your ETS project follow these steps:

- 1) Import the pr3/pr5 file in ETS and follow the instructions
  - ETS3: menu File →Import.
  - ETS4: Projects →Import projects
- 2) Open the project named Dummy Intesis.
- 3) In this Dummy Intesis project, in topology tree, you will find the device "Dummy Intesis". Select this device (click on it) and copy it (menu Edit→Copy)
- 4) Open your target project, select the desired line and paste the device there (menu Edit → Paste).

Once that is done the group addresses can be configured. To do so the same addresses configured in the LinkBoxEIB need to be written in the right data type.

## 5. LinkBoxEIB. Configuration & monitoring tool for intesisBox KNX series

### 5.1 Introduction

LinkBoxEIB is a Windows compatible software tool developed specifically to monitor and configure IntesisBox KNX series gateways. It is possible to configure all external protocols available for IntesisBox KNX and to maintain different customer's configurations based on a LinkBoxEIB project for every different installation. Maintaining always on hard disk a copy of the last configuration files for every external protocol and customer, that is to say for every project.

From LinkBoxEIB, as well as configure the integration signals list and connection parameters for every external protocol, it is permitted also to select the serial port to use to connect to IntesisBox and the use of some tools for monitoring and debugging de device. Some of these tools will be explained in this document but only some of them, the rest of available debugging tools and commands will not be explained here because they are for exclusive use under the recommendations of Intesis Software technical support.

LinkBoxEIB allows configuring all IntesisBox KNX series independently of the external system or protocol used. For every external system, LinkBoxEIB has a specific configuration window. Periodically, new free versions of LinkBoxEIB are released incorporating the latest developed integrations for external systems.

### 5.2 Project definition

The first step to do in LinkBoxEIB for a new installation is to create the installation's project giving a descriptive name to it. When you create a project, a new folder is created with the name of the project containing the configuration files needed depending on the external protocol selected for the project. It is strongly recommended that you create a new project for every installation, if not, overwriting of configuration files of previous installations using the same external protocol may occur, loosing the configuration data for those previous installations. The projects folder is located in AppFolder\ProjectsEIB, where AppFolder is the installation folder of LinkBoxEIB (by default C:\Program Files\Intesis\LinkBoxEIB). Inside the projects folder, a new folder will be created for every project defined in LinkBoxEIB with the files needed for the project.

When you open LinkBoxEIB, the project selection window will appear inviting you to select a project or to create a new one. A demo project for every external protocol supported is provided with the standard installation of LinkBoxEIB.

You can create a brand new project, which will create a blank project (only basic parameters will be already configured), or you can select a demo project based on the external protocol desired and create a new project based on this demo project selected (all the configuration of the demo project will be copied into the new project created).

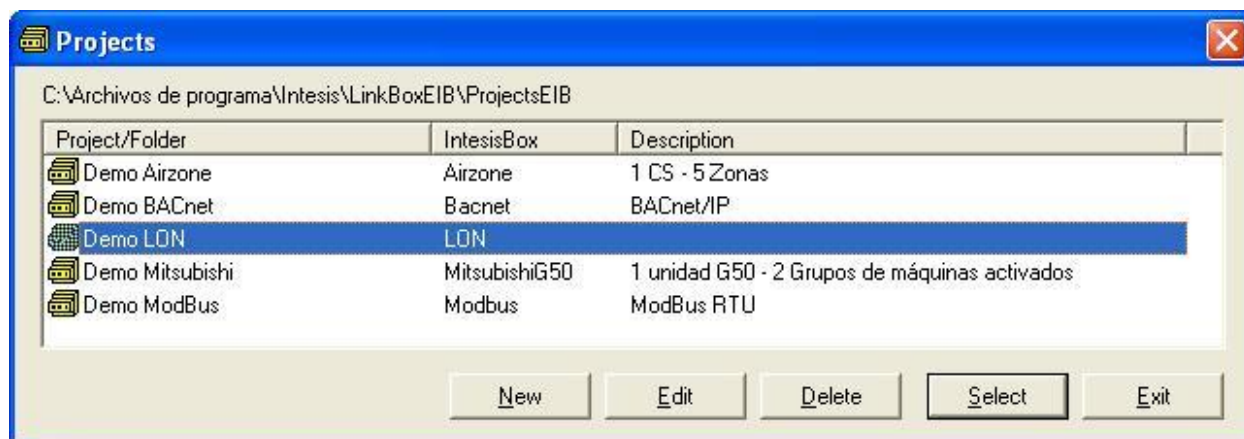

### Project selection window

To create a new project, select a project using the same external protocol you want to use in the new project and push *New* button. You will be prompted to create a copy of the selected project (useful for similar installations) or create a brand new one.

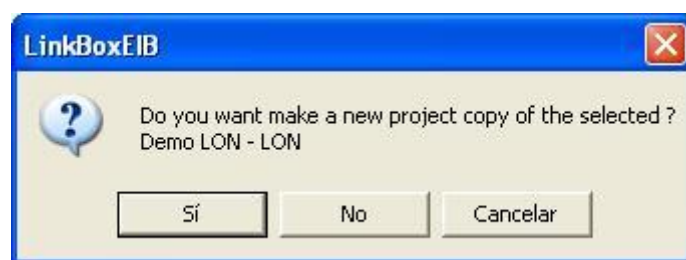

If you select *Yes*, you will be prompted to specify a name and a description for the new project that will contain a copy of the configuration of the selected one.

If you select *No*, you can specify a name, a description and an external protocol to use from the list of available external protocols. This will create a brand new project based in the external protocol specified.

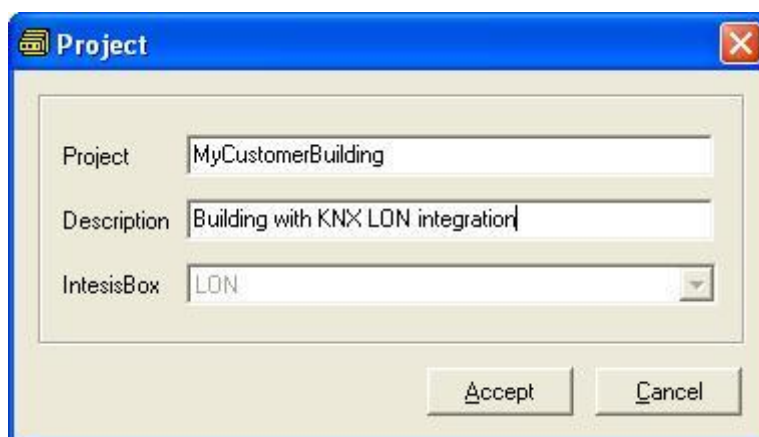

On *Accept*, a new folder will be created inside the projects folder with the name given to the project, this folder will contain the template configuration files if the project is a brand new one, or a copy of the configuration files if it is a copy of a selected one.

A description of the files created for a LON protocol based project can be found in section *Files* below in this document.

From all the possibilities of LinkBoxEIB, only changes in configuration for the integration and configuration file generation can be performed while disconnected from IntesisBox (working off-line), allowing you to do these tasks in the office more comfortably. Before any monitoring or downloading action to IntesisBox can be performed, the connection between IntesisBox and the PC running LinkBoxEIB must be established (working on-line). To do so follow these steps:

1. Make sure IntesisBox is powered-up a correctly connected to the KNX system via the EIB bus and to the LON system via the LON Bus connection (Consult details for connection and pin assignments in section *Connections* of this document).
2. Connect a free PC serial port to IntesisBox's serial port marked as **PC Console**. (Use the standard serial cable supplied with IntesisBox or make your own cable following the pin assignments specified in section *Connections* in this document).
3. Select in LinkBoxEIB the PC serial port used for the connection to IntesisBox. Use menu Configuration -> Connection.

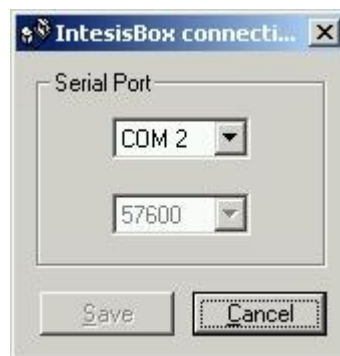

4. Check the checkbox *off-line* under the menu bar (it will change automatically to *on-line*) and LinkBoxEIB will ask for INFO about the IntesisBox connected to it via the serial connection, if the connection is ok then IntesisBox will respond with its identification (this can be monitored in the *IntesisBox Communication Console* window, as showed below).



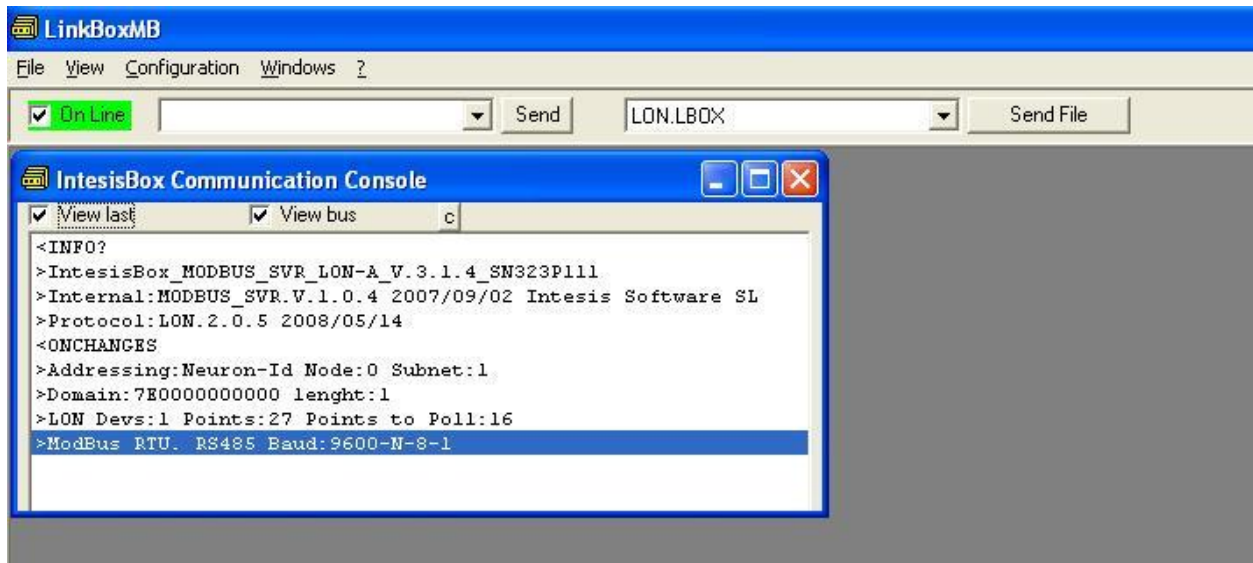

Once connected to the IntesisBox, all the options of LinkBoxEIB are fully operative.

To monitor the communication between IntesisBox and the KNX system, select the menu *View -> Bus -> EIB*. The *EIB communication Viewer* window will be opened. This window shows in real time all the communication frames between IntesisBox and the KNX system as well as debugging messages referent to the internal protocol (KNX) sent by IntesisBox.



To monitor the communication between IntesisBox and the external system (*LON* in this case), select the menu *View -> Bus -> External system*. The *External protocol communication viewer* window will be opened. This window shows in real time all the communication frames between IntesisBox and the LON devices as well as debugging messages referent to external protocol (LON) sent by IntesisBox.

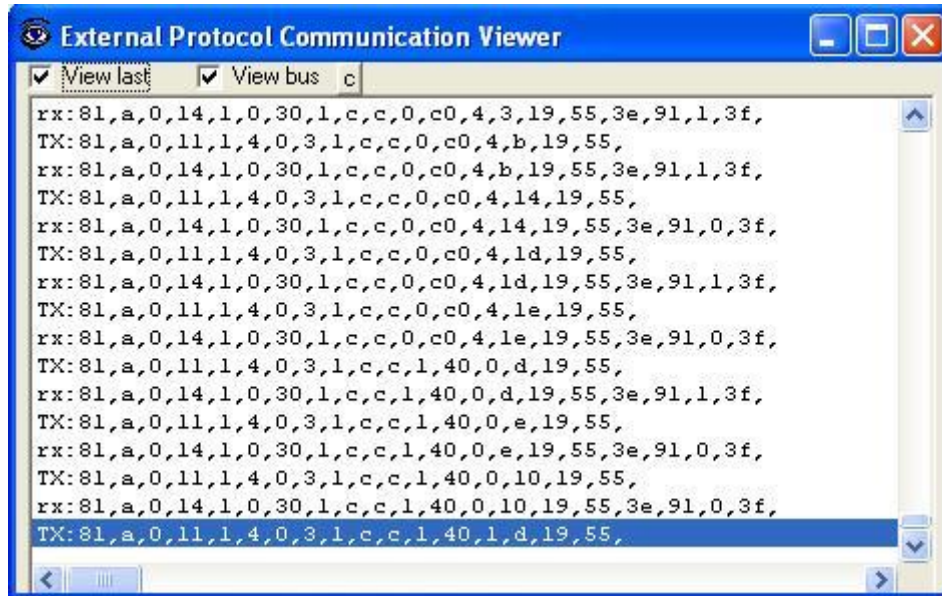

To configure the integration connection parameters, and the points list, select menu *Configuration -> IntesisBox*. The *LON Configuration* window will be opened.

### 5.3 Connection configuration

Select the Connection tab to configure the connection parameters.

Two kinds of information are configured using this window, the parameters of the KNX interface, and the parameters of the LON interface.

KNX interface configuration parameters:

EIB

15.15.250 Physical Address ← 1

Force update after an KNX bus reset. ← 2

Delay for update after bus reset. ← 3

#### KNX configuration

1. Enter the physical address desired for IntesisBox inside the KNX network.
2. Check this if you want IntesisBox to force the readings in KNX of those points configured with "U" or "U2" flag after a KNX bus reset detection.
3. Delay (in seconds) to wait before perform the readings in KNX of those points configured with "U" or "U2" flag after a KNX bus reset detection (configure it at least to 4 seconds to allow all the devices in the KNX bus to start-up correctly after a bus power failure).

LON interface configuration parameters:

IntesisBox - LON

1 → [ B5 ] Domain

2 → [ 1 ] Length Domain

3 → [ 0 ] Subnet [ 126 ] Node ← 4

5 → [ A-Basic ] Version

1. Enter the Domain number for IntesisBox into the LON network.
2. Enter the length in bytes of the Domain field.
3. Enter the Subnet number for IntesisBox into the LON network.
4. Enter the Node number for IntesisBox into the LON network.
5. Select the version of IntesisBox used.

Remember you can identify the version used by the order code printed in the front label of IntesisBox:

- **IBOX-KNX-LON-A**. Basic model supporting up to 128 LON devices and 100 points.
- **IBOX-KNX-LON-A**. Basic model supporting up to 128 LON devices and 500 points.
- **IBOX-KNX-LON-B**. Extended model supporting up to 128 LON devices and 4000 points.

You can identify also the model of IntesisBox by its identification given in response to an INFO command, it is something like this:

IntesisBox\_EIB\_LON-**100**... -> this is the tiny model.

IntesisBox\_EIB\_LON-**A**... -> this is the basic model.

IntesisBox\_EIB\_LON-**B**... -> this is the extended model.

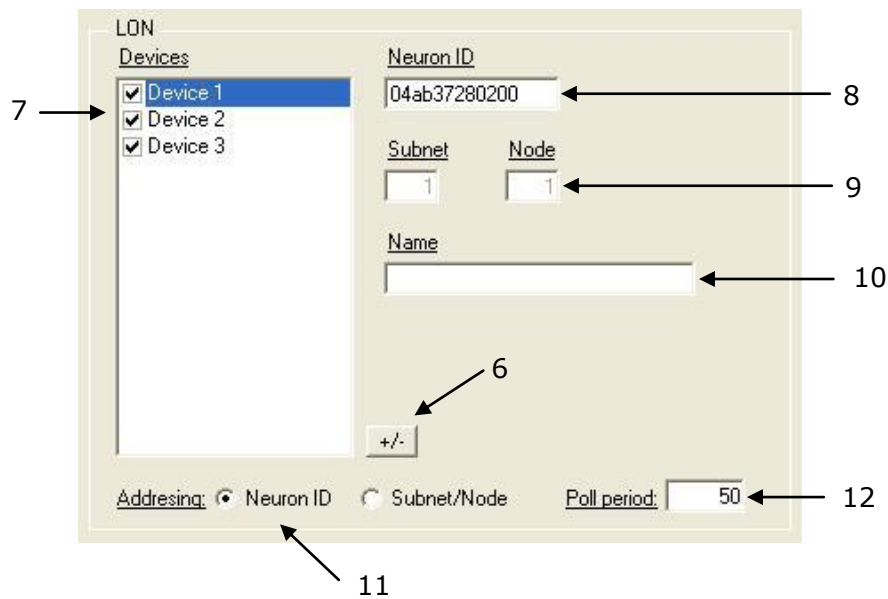

6. Use this button to define the number of LON devices to integrate. Remember the limitations: just 64 devices in IntesisBox basic model, and 128 devices in IntesisBox extended model.

7. List of LON devices to integrate. Check the devices you want to activate. Select a device to configure its properties.

For every LON device defined, these are the properties that must be entered:

8. Enter the Neuron Id, or

9. Enter the Subnet and Node number of the LON device.

10. Enter the device name (optional, just for identification purposes).

11. Enter the type of addressing to use by IntesisBox to access the device: Neuron Id or Subnet/Node. If the devices are in an already commissioned LON network, then choose Subnet/Node here and enter the correct Subnet and Node numbers of the devices (this must be supplied by the LON integrator that has commissioned the network). If the devices are not commissioned, then choose Neuron Id here and enter the correct Neuron Id numbers of the devices. IntesisBox has embedded tools to scan and detect Neuron Id numbers of the LON devices connected to the network, and also to declare the devices as commissioned, avoiding this way the need of a commissioning tool like LonMaker. See details of use of these embedded tools below in this document.

12. Device's polling cycle time period.

## 5.4 Signals configuration

Select the Signals tab to configure the signals list (the IntesisBox's internal datapoints).

#	Dev	SNVT	SNVT name	Idx	RW	Description	EIS	Group	Listening addresses	R	W	T	U	Active
1		-2	[Communication Error hard]			Communication Error hard	1 - Switching (1 bit)			R		T		0-No
2	1	-1	[Communication Error]			Communication Error	1 - Switching (1 bit)			R		T		0-No
3	1	95	SNVT_switch_filter_0_1	0	R	nvoOnOff_01 (Status OnOff:	1 - Switching (1 bit)			R		T		0-No
4	1	95	SNVT_switch_filter_0_1	1	R	nvoOnOff_02	1 - Switching (1 bit)			R		T		0-No
5	1	95	SNVT_switch_filter_0_1	2	R	nvoOnOff_03	1 - Switching (1 bit)			R		T		0-No
6	1	95	SNVT_switch_filter_0_1	3	R	nvoOnOff_04	1 - Switching (1 bit)			R		T		0-No
7	1	95	SNVT_switch_filter_0_1	4	R	nvoOnOff_05	1 - Switching (1 bit)			R		T		0-No
8	1	95	SNVT_switch_filter_0_1	5	R	nvoOnOff_06	1 - Switching (1 bit)			R		T		0-No
9	1	95	SNVT_switch_filter_0_1	6	R	nvoOnOff_07	1 - Switching (1 bit)			R		T		0-No
10	1	95	SNVT_switch_filter_0_1	7	R	nvoOnOff_08	1 - Switching (1 bit)			R		T		0-No
11	1	95	SNVT_switch_filter_0_1	8	R	nvoOnOff_09	1 - Switching (1 bit)			R		T		0-No
12	1	95	SNVT_switch_filter_0_1	9	R	nvoOnOff_10	1 - Switching (1 bit)			R		T		0-No
13	1	95	SNVT_switch_filter_0_1	10	R	nvoOnOff_11	1 - Switching (1 bit)			R		T		0-No
14	1	95	SNVT_switch_filter_0_1	11	R	nvoOnOff_12	1 - Switching (1 bit)			R		T		0-No
15	1	95	SNVT_switch_filter_0_1	12	R	nvoOnOff_13	1 - Switching (1 bit)			R		T		0-No
16	1	95	SNVT_switch_filter_0_1	13	R	nvoOnOff_14	1 - Switching (1 bit)			R		T		0-No
17	1	95	SNVT_switch_filter_0_1	14	R	nvoOnOff_15	1 - Switching (1 bit)			R		T		0-No
18	1	95	SNVT_switch_filter_0_1	15	R	nvoOnOff_16	1 - Switching (1 bit)			R		T		0-No
19	1	95	SNVT_switch_filter_0_1	16	R	nvoOnOff_17	1 - Switching (1 bit)			R		T		0-No
20	1	95	SNVT_switch_filter_0_1	17	R	nvoOnOff_18	1 - Switching (1 bit)			R		T		0-No

Integration signals configuration

Buttons: Import XIF..., Import ETS, Add, Delete, Save, Exit

Arrows 1-18 point to: 1 (#), 2 (Dev), 3 (SNVT), 4 (SNVT name), 5 (Idx), 6 (RW), 7 (Description), 8 (EIS), 9 (Group), 10 (Listening addresses), 11 (R), 12 (W), 13 (T), 14 (U), 15 (Active), 16 (Save), 17 (Add), 18 (Import XIF...)

1. **#.** Signal's number (edit not permitted). Every row in the grid corresponds to a signal (point). Signals (rows in the grid) can be added or deleted selecting the desired row and clicking *Add* or *Delete* buttons. Deletion action can be executed for a single row or even for some consecutive rows, all the rows selected will be deleted. This column is used only to enumerate the rows in the grid (signals).
2. **Dev.** Device number to which belongs the point. Referenced to the list of devices defined in *Connection Tab*. Note that this is the order number of the device (from top to bottom) in the devices list.
3. **SNVT.** SNVT Id number according to EIA-709 standard. Edit not permitted.  
The *Communication error* virtual signals have always a predefined special SNVT Id numbers -1 and -2.
4. **SNVT Name.** This is the SNVT to select for the point. Select the SNVT desired from a list of all standard SNVTs defined by LonMark International and a few special SNVTs with filter (their use explained in section 3.1), open this list by clicking the mouse right button over the column. Consult the documentation of the LON devices to integrate for details of which SNVT is used for every point into the device.
5. **Idx.** This is the index of the variable inside the LON device. Consult the device's documentation to obtain it.
6. **RW.** Indicates if the variable is of type input (W), output (R), or input/output (RW).  
*Note that an output variable in the LON device must be defined as R, to be read by the IntesisBox. And an input variable must be defined as W, to be written by the IntesisBox.*
7. **Description.** Signal's description. Used to describe the signal at user level.

8. *EIS*. KNX data type (Data point) to encode the signal's value. Possible values are: switching (1 bit), dimming (4 bit), float (16 bit), scaling (8 bit), drive control (1 bit), priority (2 bit), float IEEE (32 bit), counter (8 bit), counter (16 bit), counter (32 bit), ASCII char (8 bit). Edit using the mouse right-button-click menu available on the column.
9. *Group*. Main EIB group address for the signal. Format: P/I/S or P/S. Flags *R,W,T,U* explained below will only apply for this main EIB group address, not for listening addresses (if defined). It is the sending group address.
10. *Listening addresses*. EIB group addresses that will be listen by IntesisBox for this signal, that is to say, if IntesisBox receives an EIB telegram with destination one of these listening addresses, then the telegram will be taken into account and the corresponding action will be performed on this signal. Format: P/I/S or P/S, if more than one is entered then they must be separated by comma.
11. *R*. Indicates if this signal is allowed to be read from KNX system. Possible values: "R" or blank. "R" means flag activated. This cell is automatically filled according to value selected in the cell RW.
12. *W*. Indicates if this signal is allowed to be written from KNX system. Possible values: "W" or blank. "W" means flag activated. This cell is automatically filled according to value selected in the cell RW.
13. *T*. Indicates if this signal will generate a telegram sending to the KNX system following a change of the signal's value, that is to say, any change of value of this signal in LON side will be transmitted to the KNX system if this flag is activated. Possible values: "T" or blank. "T" means flag activated. This cell is automatically filled according to value selected in the cell RW.
14. *U*. Indicates if this signal will be updated whenever IntesisBox starts up or after an EIB bus reset. "U" means flag activated for the main EIB group address (a read of the main EIB group address will be performed in the KNX system for the update). "U2" means flag activated for the first listening address defined (a read of the first listening address defined for the point will be performed in the KNX system for the update). Blank means flag not activated. Edit using the mouse right-button-click pop-up menu available on the column. Configurable only for input LON variables (W).
15. *Active*. Indicates if the signal is active or not for the integration. Possible values: 0-No, 1-Yes. Edit using the mouse right-button-click menu available on the column.
16. Buttons to move the selected row (or rows) up or down inside the grid. To move up or down inside the grid a single row or a group of consecutive rows, just select the row or rows using the left button of the mouse and push the desired up or down button. (This can be done also using the key combinations *ALT+arrow up* or *ALT+arrow down* instead of up or down buttons).

Useful tips for a more quick and comfortable use and configuration of the signals table:

The columns *SNVT Name*, *RW*, *EIS*, *U* and *Active* can be modified selecting one or just more than one consecutive cells in the same column and using the contextual menu appearing with mouse right button click over the cells selected.

The columns *U* and *Active* can be also modified using mouse-left-button double-click over the desired cell.

In column *Dev* you can enter the desired value individually per cell or you can auto enumerate some consecutive cells, for this last follow these steps:

1. Select using the left mouse button (clicking and dragging) the *Dev* field of all the rows in the list to which you want to automatically assign values (must be consecutive rows).
2. Click right mouse button over the selected fields and select *Auto Enumeration* option from the pop-up menu that will appear.

	Dev	SNVT	Idx
1		[Communication Error]	
2	-1	[Communication Error]	
3	95	SNVT_switch_filter_0_1	0
4	95	SNVT_switch_filter_0_1	1
5	95	SNVT_switch_filter_0_1	2
6	95	SNVT_switch_filter_0_1	3
7	95	SNVT_switch_filter_0_1	4
8	95	SNVT_switch_filter_0_1	5
9	100	SNVT_density	6
10	95	SNVT_switch_filter_0_1	7
11	95	SNVT_switch_filter_0_1	8
12	95	SNVT_switch_filter_0_1	9
13	95	SNVT_switch_filter_0_1	10
14	95	SNVT_switch_filter_0_1	11
15	95	SNVT_switch_filter_0_1	12
16	95	SNVT_switch_filter_0_1	13
17	95	SNVT_switch_filter_0_1	14

3. Enter the first value to assign.



4. Enter the increment between consecutive assignments. For example selecting 0 for the first value and an increment of 1, the values generated will be 0,1,2,3,4.. and so on. To assign the same value to all the rows (useful to assign the same Device number in the column *Dev* for some consecutive rows) just select the desired value and an increment of 0.

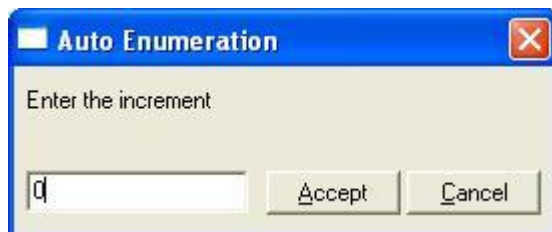

### 5.4.1 Remember

- If "T" is not activated, the changes in the external system (BACnet) will not be transmitted to the KNX.
- If "R" is not activated, the KNX group address could not be read by Read Requests from KNX.
- If "W" is not activated, no write on the group address could be done from KNX, neither on the links (listening addresses).
- If "U" is activated, after IntesisBox start-up or a KNX bus reset, READ Requests will be sent to KNX to update the sending group.
- The groups defined as just links, will take the EIS of the first linked group.
- The data of the groups read from KNX due to read requests between other KNX devices, will be treated as writes on the groups (standard behaviour BCU1).
- Automatic type conversion is performed by IntesisBox, for example if an EIS5 is received by a group of type EIS1, then it is performed the conversion  $EIS1=(EIS5<>0)$ , or  $EIS5=EIS9$  and  $EIS9=EIS5$ ,  $EIS6=EIS5(0..255)$ , etc.
- It is recommended that listening addresses associated to different groups maintain the same EIS in all the groups, if not, none desired conversions can be performed.
- A write from KNX is propagated to the external system through the group address and also through the listening addresses.
- A write from the external system is NOT propagated to KNX through the listening addresses, but DO update the local sending groups that are used as listening addresses.
- If a sending group is used as listening address with other local sending groups, a write from the external system will update the sending group but not the listening addresses.

### 5.4.2 Restrictions

- It is allowed group numbers in format P/I/S, P/S or directly the group number coded.
- It is not allowed duplicated sending groups (column Group).
- Group 0 is not allowed, it is used for signals without sending group.
- NO signal is allowed with none of R-W-T-U flags activated.
- Empty groups are allowed, but only if they have just W activated and one or more listening addresses.
- Duplicated groups in the same listening address field are not allowed.
- It is not allowed a listening address that is the same as the sending group (circular reference).
- Listening addresses are not allowed if the flag W is not activated. Without W activated, the listening addresses would not work.
- Only those EIS defined are allowed.

## 5.5 Saving the configuration and sending it to IntesisBox

When the configuration is finished, click on button *Save* to save it to the project folder on hard disk. You will be prompted to generate the configuration file to send to IntesisBox, if you select *Yes*, the binary file containing the configuration for IntesisBox will be generated and saved also into the project folder.

Once the configuration has been saved and the configuration file for IntesisBox has been generated, to send this configuration file to IntesisBox, click on the button **Send File**. The process of file transmission can be monitored in the IntesisBox Communication Console window. If the file transmission is ok, IntesisBox will reboot automatically with the new configuration loaded.

## 5.6 Signals viewer

Once IntesisBox is running with the correct configuration, to supervise the status of the configured signals, select menu *View -> Signals*. The Signals Viewer window will be opened. This window shows all the active IntesisBox's signals with its main configuration parameters and its real time value in the column Value. After a reset of IntesisBox or after sending a configuration file to the IntesisBox, all the signal's values will be updated automatically in the signals viewer, in case you connect to the IntesisBox when it is already running, you should press the *Update* button to get updated values, press just once the button to update all the signal values, from this moment the signal values will be maintained updated until the connection is closed.

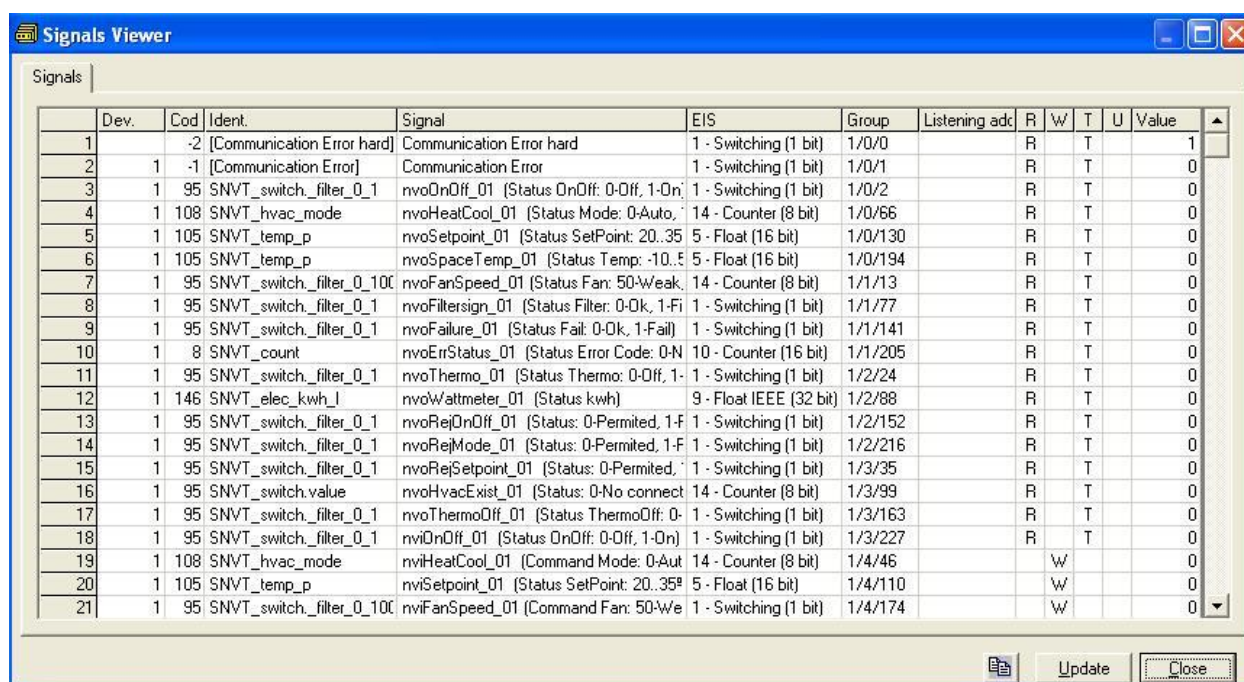

Dev.	Cod	Ident.	Signal	EIS	Group	Listening	ad	R	W	T	U	Value
1	-2	[Communication Error hard]	Communication Error hard	1 - Switching (1 bit)	1/0/0			R		T		1
2	1	-1 [Communication Error]	Communication Error	1 - Switching (1 bit)	1/0/1			R		T		0
3	1	95 SNVT_switch_filter_0_1	nvoOnOff_01 (Status OnOff: 0-Off, 1-On)	1 - Switching (1 bit)	1/0/2			R		T		0
4	1	108 SNVT_hvac_mode	nvoHeatCool_01 (Status Mode: 0-Auto, 1-Off)	14 - Counter (8 bit)	1/0/66			R		T		0
5	1	105 SNVT_temp_p	nvoSetpoint_01 (Status SetPoint: 20..35)	5 - Float (16 bit)	1/0/130			R		T		0
6	1	105 SNVT_temp_p	nvoSpaceTemp_01 (Status Temp: -10..5)	5 - Float (16 bit)	1/0/194			R		T		0
7	1	95 SNVT_switch_filter_0_100	nvoFanSpeed_01 (Status Fan: 50-Weak)	14 - Counter (8 bit)	1/1/113			R		T		0
8	1	95 SNVT_switch_filter_0_1	nvoFiltersign_01 (Status Filter: 0-Ok, 1-Fail)	1 - Switching (1 bit)	1/1/77			R		T		0
9	1	95 SNVT_switch_filter_0_1	nvoFailure_01 (Status Fail: 0-Ok, 1-Fail)	1 - Switching (1 bit)	1/1/141			R		T		0
10	1	8 SNVT_count	nvoErrStatus_01 (Status Error Code: 0-Normal)	10 - Counter (16 bit)	1/1/205			R		T		0
11	1	95 SNVT_switch_filter_0_1	nvoThermo_01 (Status Thermo: 0-Off, 1-On)	1 - Switching (1 bit)	1/2/24			R		T		0
12	1	146 SNVT_elec_kwh_I	nvoWattmeter_01 (Status kwh)	9 - Float IEEE (32 bit)	1/2/88			R		T		0
13	1	95 SNVT_switch_filter_0_1	nvoRejOnOff_01 (Status: 0-Permitted, 1-Forbidden)	1 - Switching (1 bit)	1/2/152			R		T		0
14	1	95 SNVT_switch_filter_0_1	nvoRejMode_01 (Status: 0-Permitted, 1-Forbidden)	1 - Switching (1 bit)	1/2/216			R		T		0
15	1	95 SNVT_switch_filter_0_1	nvoRejSetpoint_01 (Status: 0-Permitted, 1-Forbidden)	1 - Switching (1 bit)	1/3/35			R		T		0
16	1	95 SNVT_switch.value	nvoHvacExist_01 (Status: 0-No connect)	14 - Counter (8 bit)	1/3/99			R		T		0
17	1	95 SNVT_switch_filter_0_1	nvoThermoOff_01 (Status ThermoOff: 0-Off, 1-On)	1 - Switching (1 bit)	1/3/163			R		T		0
18	1	95 SNVT_switch_filter_0_1	nviOnOff_01 (Status OnOff: 0-Off, 1-On)	1 - Switching (1 bit)	1/3/227			R		T		0
19	1	108 SNVT_hvac_mode	nviHeatCool_01 (Command Mode: 0-Aut)	14 - Counter (8 bit)	1/4/46				W			0
20	1	105 SNVT_temp_p	nviSetpoint_01 (Status SetPoint: 20..35)	5 - Float (16 bit)	1/4/110				W			0
21	1	95 SNVT_switch_filter_0_100	nviFanSpeed_01 (Command Fan: 50-Weak)	1 - Switching (1 bit)	1/4/174				W			0

The signals viewer can be used although only one system is connected to the IntesisBox, *KNX* or *LON*, and is very useful for supervision and test.

It is possible to force a specific value to any signal for test purposes, to do so just double click on the row and select the desired value and Accept in the Data Test window. If the signal has W-T activated, its value will be updated and a telegram will be sent to KNX indicating the new value, the same way as if it has been received from *LON* system. If the signal has W activated, the new value entered will be sent to the external system, *LON* in this case, the same way as if it has been received from *KNX*.



This tool is very useful to test any of the systems connected to the IntesisBox, KNX and LON without the need to actuate on the real signals.

The signals viewer window has a button to copy to the Windows Clipboard all the contents of the window (in tab separated text format).

## 5.7 System commands

LinkBoxEIB includes an option to send to IntesisBox a set of system commands for debugging and control purposes; this list is available in the commands list as shown in the figure below. To send a command to IntesisBox just select it from the list, or type it with the correct format, and press *Enter* or click on button *Send*. IntesisBox will act accordingly with the command received; the process can be monitored in the IntesisBox Communication Console window. The use of some of these commands can be critical for IntesisBox normal operation, having this in mind use only these commands following the recommendations of Intesis Software technical support. A list of the more commonly used commands and the way to use them will be returned by IntesisBox after sending the HELP command.

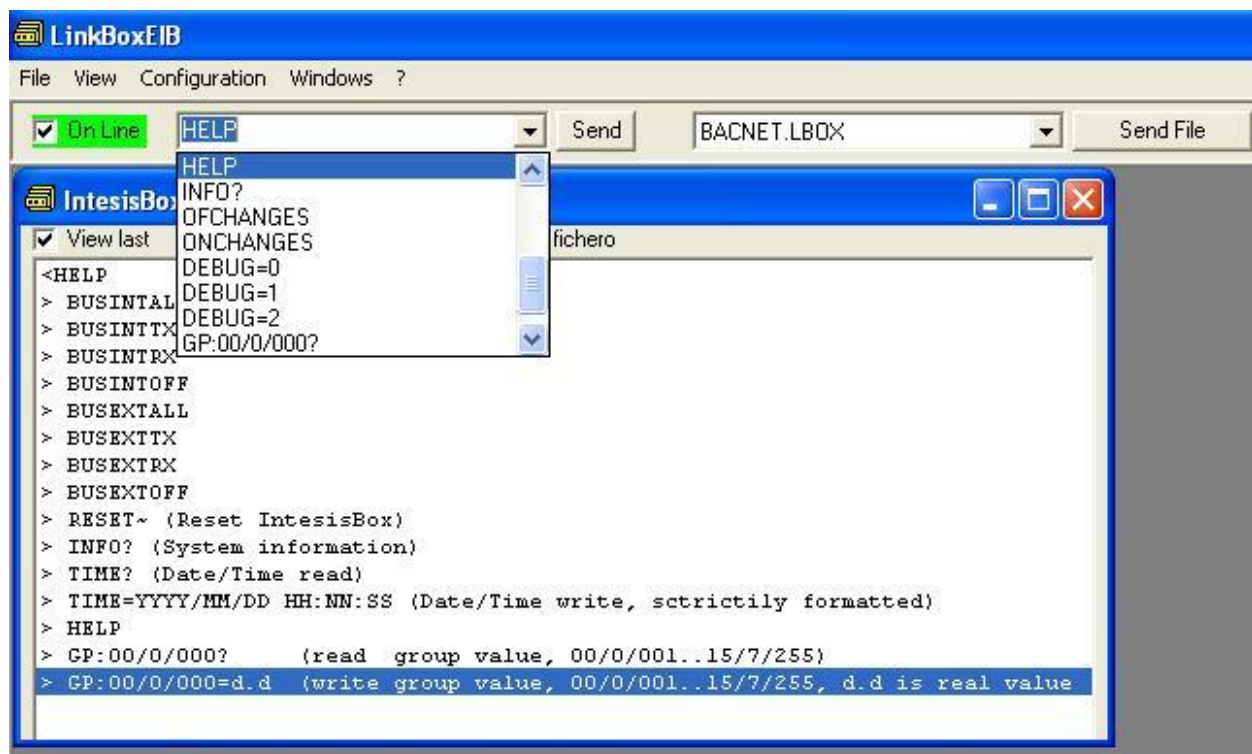

## 5.8 Files

LinkBoxEIB saves IntesisBox configuration in the following files inside the project folder:

PROJECT.INI	Ini file containing general information referent to the project
LON.INI	Ini file containing the information referent to the connection window and other special adjustments
LON.DAT	Text file (tab separated values) with the signals information (signals list). This file can be edited (with Excel for example) to change the configuration quicker and easier. Later on, when selecting <i>Configuration -&gt; IntesisBox</i> in LinkBoxEIB, if the changes have been made respecting the correct format, all the changes in the configuration done from Excel can be seen in the signals list.
LON.SNVT	File containing the SNVTs used in the project, the standard and the specific ones.
LON.LBOX	Binary file created from the information in the files described above. This is the file really uploaded to IntesisBox.

It is strongly recommended to back up the project folder containing these files in external media, once the installation process is finished. This way you will be able to do future configuration changes in case of reinstallation of LinkBoxEIB due, for example, to a failure of the hard disk in the PC where LinkBoxEIB was previously installed.

***The configuration cannot be downloaded from IntesisBox to LinkBoxEIB, only can be uploaded; the upload file LON.LBOX does not contain all the integration information, as for example the signals description.***

## 6. Setup process and troubleshooting

### 6.1 Pre-requisites

It is necessary to have a KNX TP-1 (EIB) system operative and ready to be connected to the KNX port of IntesisBox.

It is necessary to have the LON network connection beside IntesisBox with all LON devices connected to this network.

Connectors, connection cables, PC for LinkBoxEIB, and network hub or switch are not supplied by Intesis Software for this standard integration. The items supplied by Intesis Software for this integration are:

- IntesisBox KNX gateway with KNX internal protocol and LON external protocol firmware loaded.
- Console cable. Standard DB9F-DB9M cable 1.8 meters long.
- LinkBoxEIB software.
- Product documentation.

### 6.2 Setup procedure

1. Install LinkBoxEIB on your laptop.
2. Install IntesisBox in the desired installation site. The mounting can be on DIN rail or on a stable not vibrating surface (DIN rail mounting inside a metallic industrial cabinet connected to ground is recommended).
3. Connect the KNX TP-1 (EIB) bus cable to the port marked as **KNX TP-1 (EIB)** of IntesisBox. (See details for this bus cable in section *Connections* of this document).
4. Connect the LON bus cable coming from the LON network to the port marked as **LON** of IntesisBox. (See details for this communication cable in section *Connections* of this document).
5. Power up IntesisBox using a standard power supply 220/125VAC-12VDC/300mA for example.

**WARNING!** In order to avoid earth loops that can damage IntesisBox and/or any other equipment connected to it, we strongly recommend:

- The use of DC power supplies, floating or with the negative terminal connected to earth. **Never use a DC power supply with the positive terminal connected to earth.**
  - The use of AC power supplies only if they are floating and not powering any other device.
6. Connect the communication cable coming from the serial port of your laptop PC to the port marked as **PC Console** of IntesisBox. (See details for this communication cable in section *Connections* of this document).
  7. Open LinkBoxEIB, create a new project selecting a copy of the one named **DEMO LON** and give it the name desired, select the serial port used to connect to IntesisBox (menu Configuration -> Connection) and switch working mode to *on-line*

(checkbox *off-line/on-line*). The IntesisBox identification must appear in the *IntesisBox communication console* window as showed below.

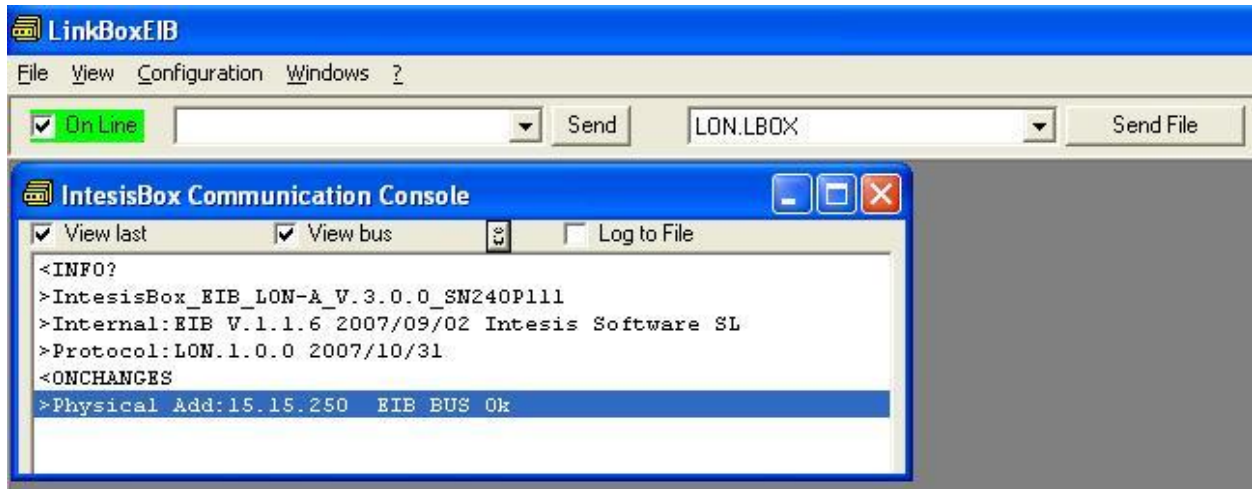

- Open the *EIB Communication Viewer* window (menu View -> Bus -> EIB) and check that there is communication activity, some TX frames and some other rx frames. This means that the communication with the KNX system is ok. In case there is no communication activity between IntesisBox and the KNX system check that KNX bus is operative and well connected to the IntesisBox.

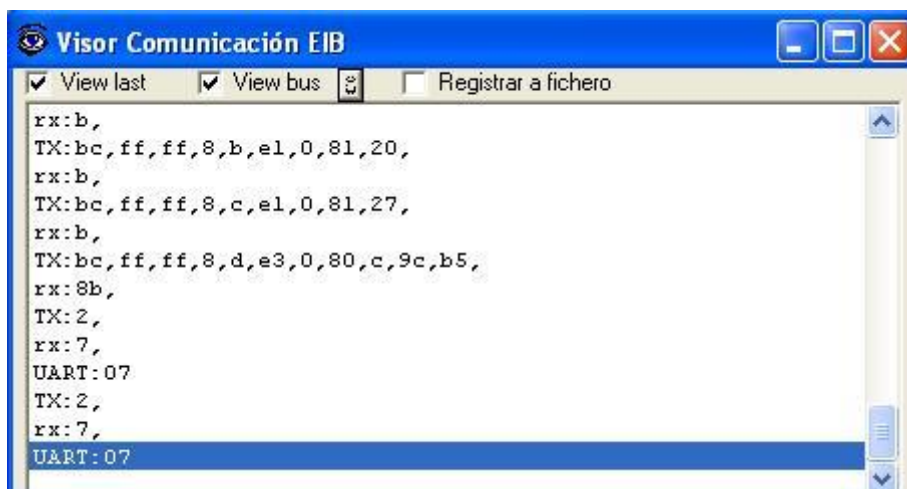

- Open the *External Protocol Communication Viewer* window (menu View -> Bus -> External system) and check that there is communication activity, some TX frames and some other rx frames as showed in the figure below. This means that the communication with the LON devices is ok.



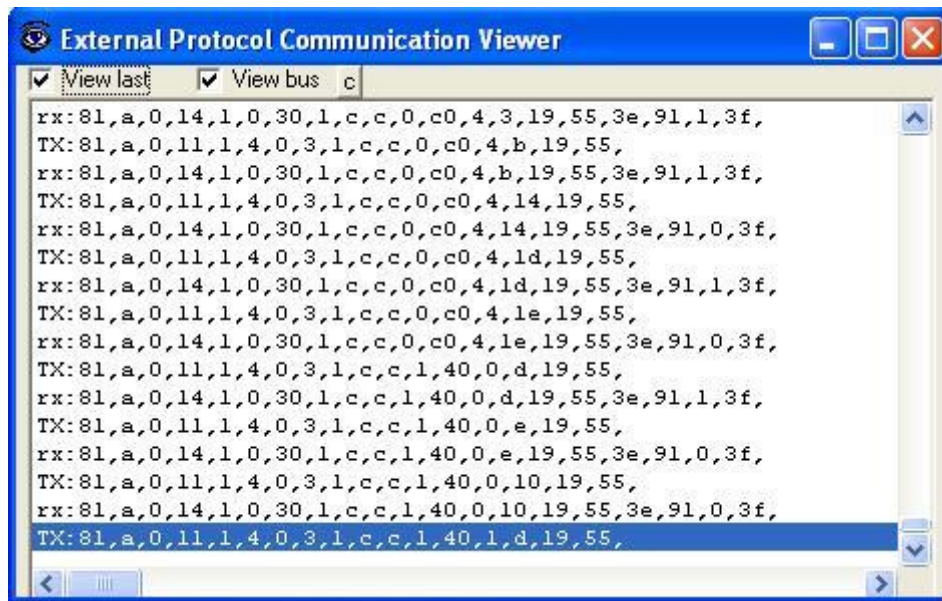

In case there is no response from the LON devices to the frames sent by IntesisBox, check that they are operative and reachable from the network connection used by IntesisBox. See details for the communication cable between IntesisBox and LON devices in section *Connections* of this document.

## 7. Connections

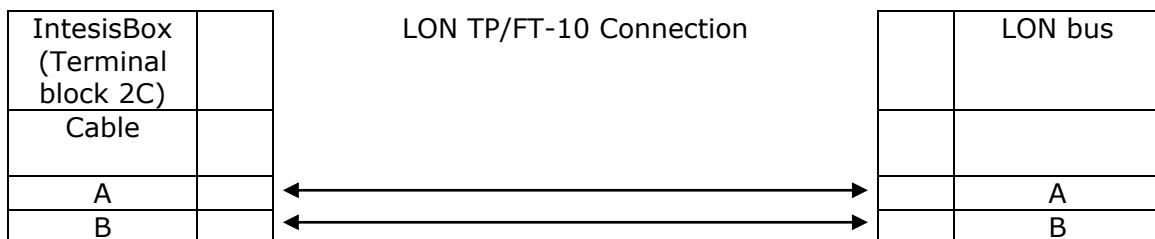
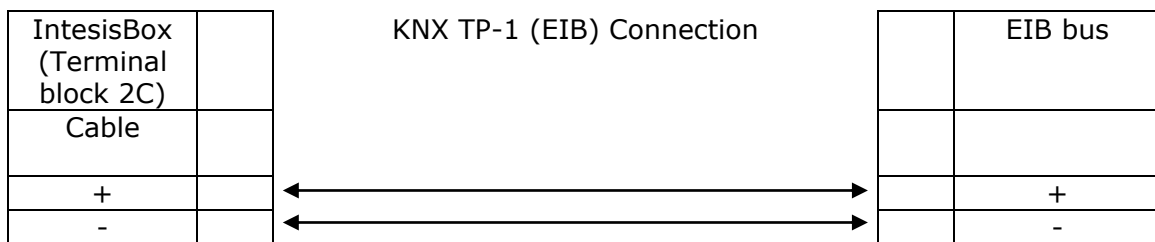
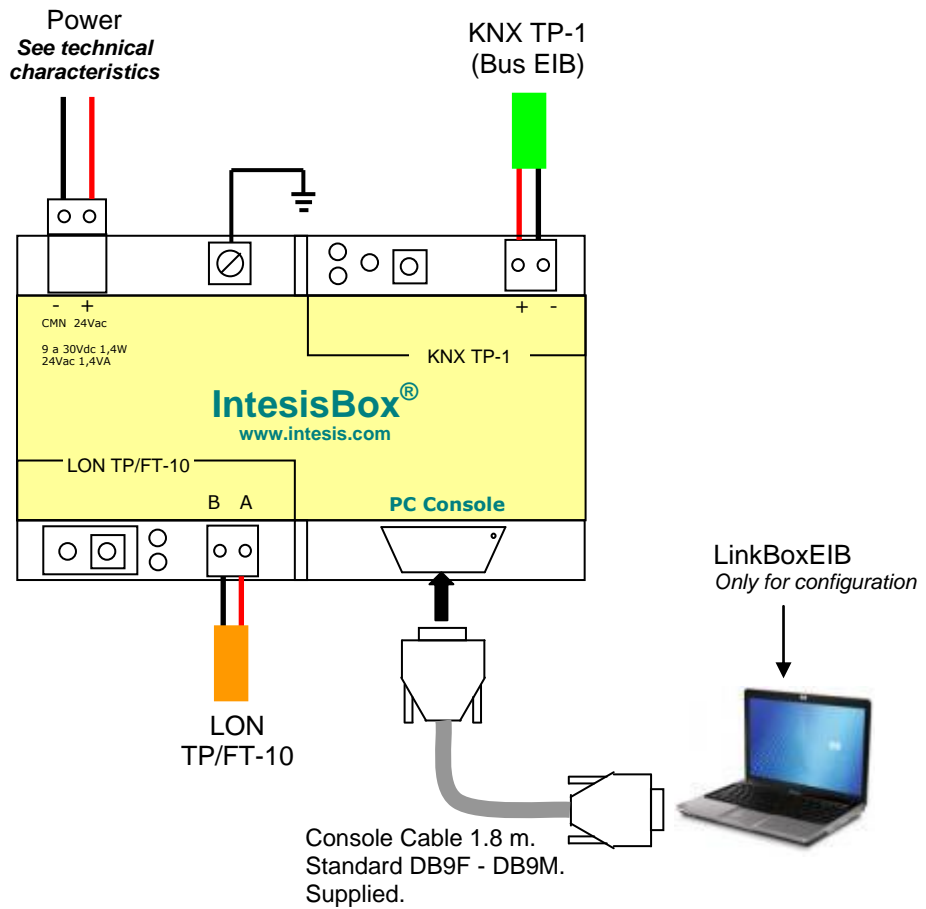

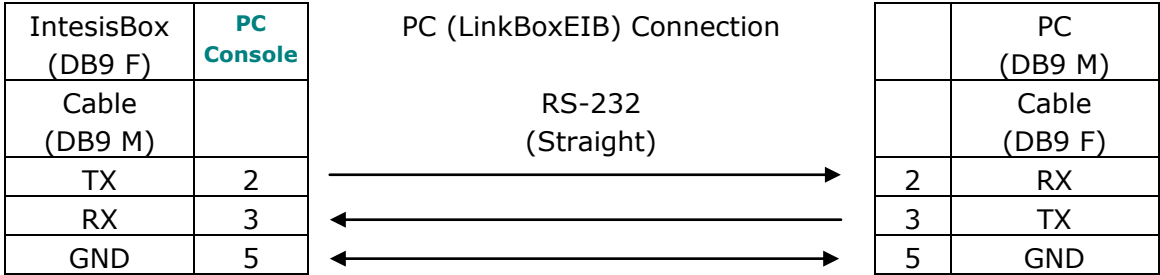

## 8. LON interface specifications

LON supported channel: Free Topology (FT-10).

Configurable addressing options (on a 'per device' basis):

- Subnet / node
- Neuron-Id

Network variable sample rate:

- Below 60ms per network variable (each network variable may contain several fields, which will be mapped to different KNX points, if needed).

Supported network variable types:

- All standard network variable types published by LonMark International are directly supported by configuration tool, *LinkBoxEIB*.
- Support for user-defined network variable types can be added in each case, by entering their definition in *LinkBoxEIB*. In this case, following information needs to be provided:
  - Scale factors:  $a$ ,  $b$  and  $c$
  - Number of fields
  - Basic LON data type of each field

### 8.1 Supported basic LON data types

Basic LON data type	Description
Signed short	8-bit signed data
Unsigned short	8-bit unsigned data
Enum	8-bit unsigned data
Signed long	16-bit signed data
Unsigned long	16-bit unsigned data
Signed quad	32-bit signed data
Unsigned quad	32-bit unsigned data
Float	32-bit IEEE float
Bitfield	1 to 8-bit length unsigned bitfield

## 9. Technical characteristics



Enclosure	Plastic, type PC (UL 94 V-0). Dimensions: 107mm x 105mm x 58mm.
Colour	Light Grey. RAL 7035.
Power	9 to 30Vdc +/-10% 1.4W. 24Vac +/-10% 1.4VA. Plug-in terminal block for power connection (2 poles).
Mounting	Wall. DIN rail EN60715 TH35.
LON port	1 x LON (TP-FT/10). Plug-in terminal block (2 poles).
KNX port	1 x KNX TP1 (EIB) port opto-isolated. Plug-in terminal block (2 poles).
LED indicators	1 x Power. 2 x KNX port activity (Tx, Rx). 2 x LON port activity (Tx, Rx). 1 x KNX programming/bus. <sup>1</sup> 1 x LON service led. <sup>1</sup>
Push buttons	1 x KNX programming. <sup>1</sup> 1 x LON service switch. <sup>1</sup>
Console port	RS232. DB9 female connector (DCE).
Configuration	Via console port. <sup>2</sup>
Firmware	Allows upgrades via console port.
Operational temperature	-25°C to +70°C
Operational humidity	25-90% at 50°C, non condensing
Protection	IP20 (IEC60529).
RoHS conformity	Compliant with RoHS directive (2002/95/CE).
Certifications	CE

<sup>1</sup> Not operational for the moment. Reserved for future use.

<sup>2</sup> Standard cable DB9male-DB9female 1,8 meters long is supplied with the device for connection to a PC COM port for configuring and monitoring the device. The configuration software, compatible with Windows® operating systems, is also supplied.

## 10. Dimensions

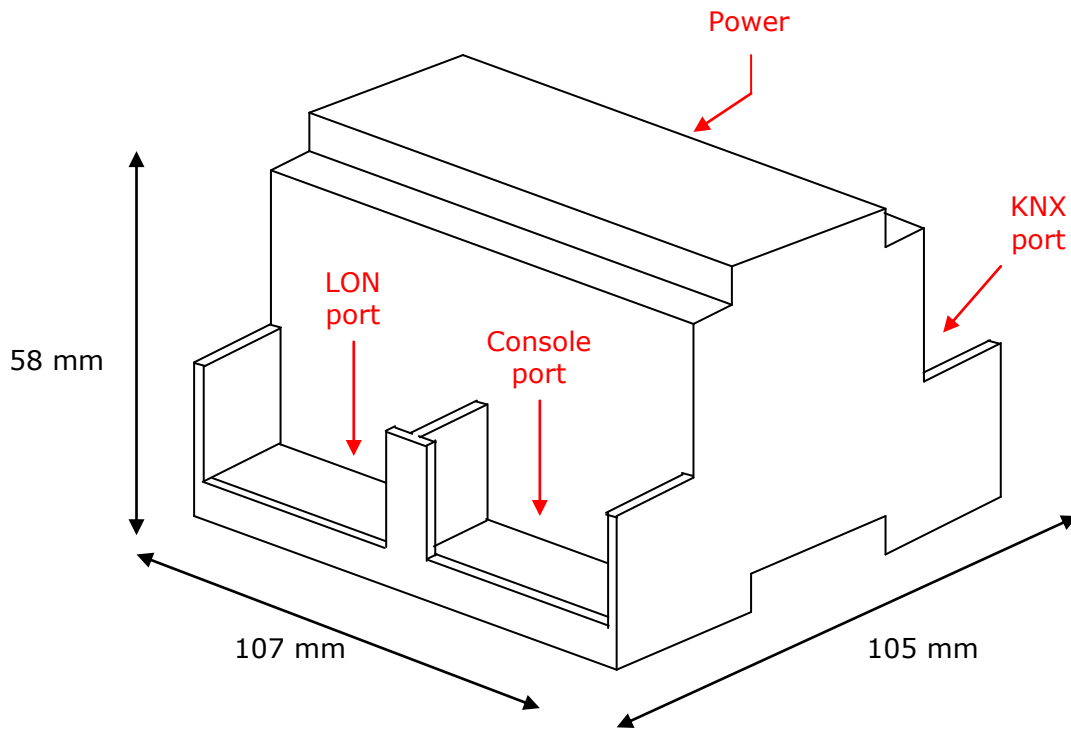

Recommended available space for its installation into a cabinet (wall or DIN rail mounting), with space enough for external connections:

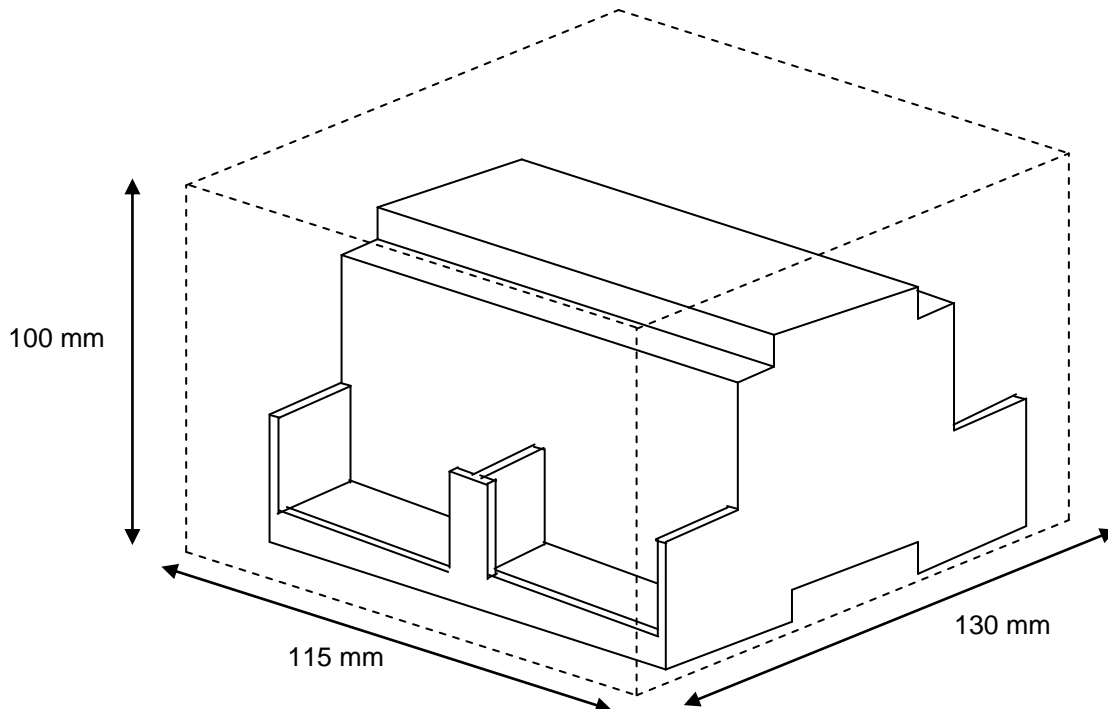

## 11. Annexes

### 11.1 Integration of DAIKIN VRV air conditioning systems with KNX

One of the main applications of *IntesisBox KNX - LON* is the integration of Daikin VRV air conditioning systems with KNX building control systems.

For this application, Daikin VRV Air Conditioning system must be equipped with Daikin LON gateway (model DMS504B51), this Daikin gateway is normally commissioned by Daikin technical personnel, contact your nearest Daikin distributor for details.

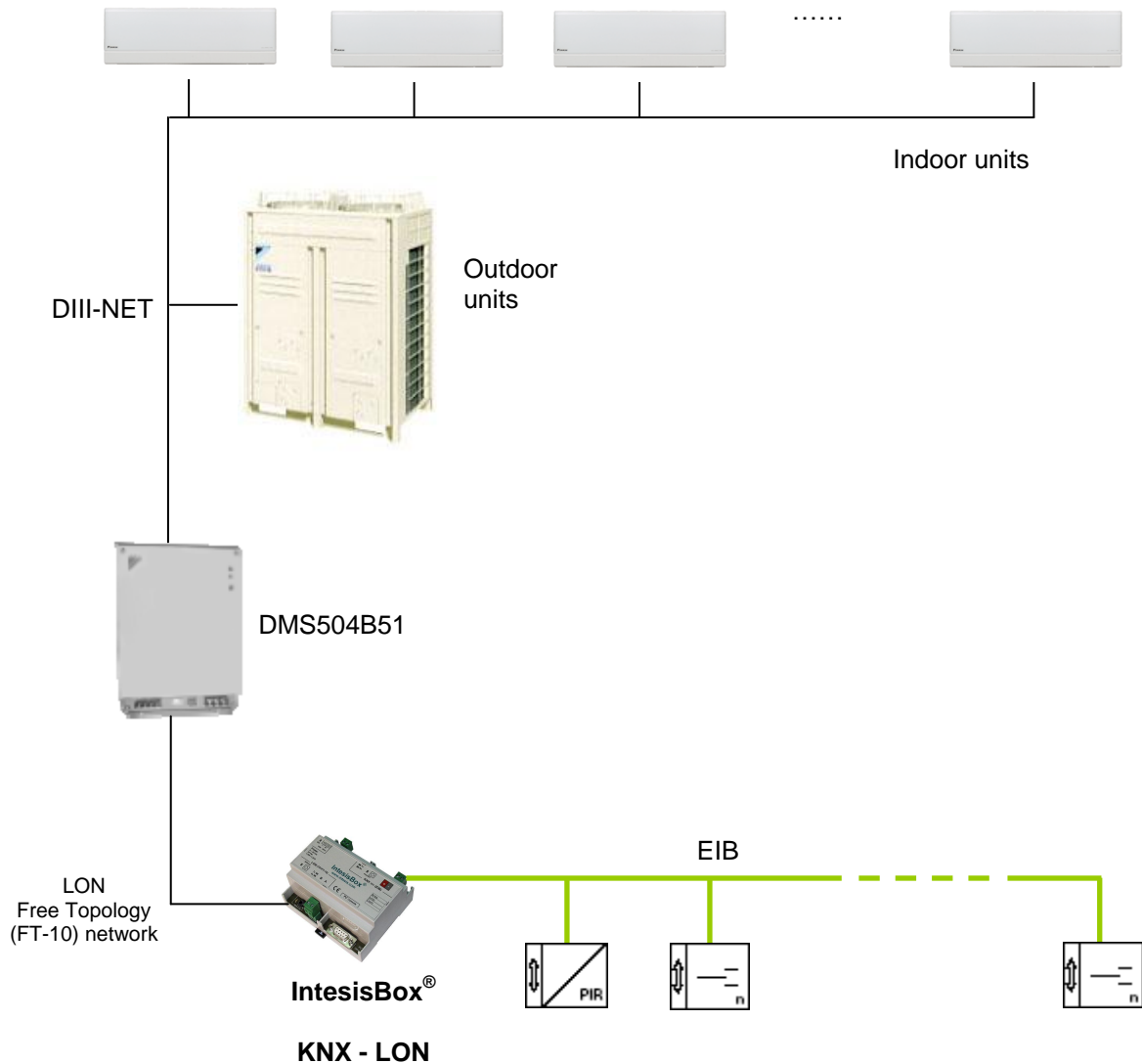

### 11.1.1 Using LinkBoxEIB to configure and setup the integration

The DMS504B51 LON gateway from Daikin allows to monitor / control up to 64 VRV indoor units. It is important to consult Daikin documentation to configure successfully the integration.

With LinkBoxEIB, it comes an example project called **DEMO LON Daikin** which contains the definition of all available variables to integrate the full capacity of the DMS504B51 (64 indoor units).

Using this Demo project as template, it will only be necessary to activate those signals needed for your integration and enter for them the corresponding KNX parameters according to your KNX installation, this makes the engineering needed to set up this integration very easy and quick.

The signals available in this Demo project for this integration and their possible values from KNX are showed below.

DAIKIN		KNX					
Individual Monitoring/Control variables per air conditioner (suffix "_xx" indicates the aircon unit number, 01 to 64)							
Variable Name	Description	Monitoring / Control	Possible values	EIS	R	W	T
nvoOnOff_xx	Monitors ON/OFF status of the air conditioner	Monitoring	0-Off, 1-On	1 - Switching (1 bit)	R		T
nvoHeatCool_xx	Monitors operation mode status (heating/cooling/ventilation) of the air conditioner	Monitoring	1-Heat, 2-Cool, 3-Vent	14 - Counter (8 bit)	R		T
nvoSetpoint_xx	Monitors the set room temperature	Monitoring	20..35°C Cool, 15..30°C Heat	5 - Float (16 bit)	R		T
nvoSpaceTemp_xx	Monitors the room temperature	Monitoring	-10..50°C	5 - Float (16 bit)	R		T
nvoFanSpeed_xx	Monitors the set airflow rate	Monitoring	0-Weak, 1-Strong	1 - Switching (1 bit)	R		T
nvoFiltersign_xx	Checks limits of filter use and monitors if it has reached the limit	Monitoring	0-Ok, 1-Filter sign	1 - Switching (1 bit)	R		T
nvoFailure_xx	Monitors error status of the air conditioner	Monitoring	0-Ok, 1-Fail	1 - Switching (1 bit)	R		T
nvoErrStatus_xx	Displays the manufacturer-specified error code if any error occurs	Monitoring	0-No error,1..23114-Error Code	10 - Counter (16 bit)	R		T
nvoThermo_xx	Monitors whether the air conditioner's thermostat is working	Monitoring	0-Off, 1-On	1 - Switching (1 bit)	R		T
nvoWattmeter_xx	Monitors the Wattmeter of the air conditioner	Monitoring	kwh	9 - Float IEEE (32 bit)	R		T
nvoRejOnOff_xx	Monitors the status if the air conditioner is permitting/prohibiting remote ON/OFF control with a hand-held controller	Monitoring	0-Permitted, 1-Prohibited	1 - Switching (1 bit)	R		T
nvoRejMode_xx	Monitors the status if the air conditioner is permitting/prohibiting remote control operation mode with a hand-held controller	Monitoring	0-Permitted, 1-Prohibited	1 - Switching (1 bit)	R		T
nvoRejSetpoint_xx	Monitors the status if the air conditioner is permitting/prohibiting remote control temperature setting with a hand-held controller	Monitoring	0-Permitted, 1-Prohibited	1 - Switching (1 bit)	R		T
nvoHvacExist_xx	Monitors the communication status (No Occupancy / Communication normal / Communication error) of the air conditioner	Monitoring	0-No connection, 1-Ok, 2-Error communication	14 - Counter (8 bit)	R		T
nvoThermoOff_xx	Monitors the forced thermostat OFF status	Monitoring	0-Reset, 1-Set	1 - Switching (1 bit)	R		T
nviOnOff_xx	Starts/stops air conditioner operation	Control	0-Off, 1-On	1 - Switching (1 bit)		W	
nviHeatCool_xx	Sets operation mode	Control	0-Auto, 1-Heat, 2-Cool, 3-Vent	14 - Counter (8 bit)		W	
nviSetpoint_xx	Sets room temperature	Control	20..35°C Cool, 15..30°C Heat	5 - Float (16 bit)		W	



nviFanSpeed_xx	Sets airflow rate	Control	0-Weak, 1-Strong	1 - Switching (1 bit)		W	
nviFSReset_xx	Resets filter sign	Control	From 0 to 1 => Reset Filter Sign	1 - Switching (1 bit)		W	
nviRejOnOff_xx	Sets whether permit/prohibit ON/OFF control rejection of the air conditioner with a hand-held remoter controller	Control	0-Permitted, 1-Prohibited	1 - Switching (1 bit)		W	
nviRejMode_xx	Sets whether permit/prohibit operation mode control rejection of the air conditioner with a hand-held remote controller	Control	0-Permitted, 1-Prohibited	1 - Switching (1 bit)		W	
nviRejSetpoint_xx	Sets whether permit/prohibit room temperature setting control rejection of the air conditioner with a hand-held remote controller	Control	0-Permitted, 1-Prohibited	1 - Switching (1 bit)		W	
nviThermoOff_xx	Sets forced thermostat OFF	Control	0-Reset, 1-Set	1 - Switching (1 bit)		W	

**General Monitoring/Control variables**

Variable Name	Description	Monitoring / Control	Possible values	EIS	R	W	T
Communication Error hard	Monitors IBOX internal communication handler	Monitoring	0-Ok, 1-Error	1 - Switching (1 bit)	R		T
Communication Error	Monitors the communication between IBOX and DMS-IF	Monitoring	0-Ok, 1-Error	1 - Switching (1 bit)	R		T
nvoSystemOff	Monitors the status of the forced OFF setting of the air conditioners connected to the DIII-NET	Monitoring	0-Normal, 1-ForcedOFF	1 - Switching (1 bit)	R		T
nvoRejLC	Monitors whether the operation of centralized devices on the DIII-NET is permitted/prohibited	Monitoring	0-Permitted, 1-Prohibited	1 - Switching (1 bit)	R		T
nviSystemOff	Forcibly stops the air conditioners connected to the DIII-NET / Resets the Forced OFF setting	Control	0-Reset, 1-ForcedOFF	1 - Switching (1 bit)		W	
nviRejLC	Controls whether the operation of centralized devices on the DIII-NET is permitted/prohibited	Control	0-Permitted, 1-Prohibited	1 - Switching (1 bit)		W	

R = Datapoint can be read from KNX

W = Datapoint can be written from KNX

T = New value received is transmitted automatically to KNX

\* Monitoring/Control of the same Daikin variable (i.e. nvoOnOff/nviOnOff) can be done through a single KNX group address using "listening addresses" in IntesisBox

**Note:** In the Daikin system configuration, sometimes the VRVs are configured as masters and sometimes as slaves, the ones configured as slaves do not accept commands because they work in parallel with their masters.

Also available sample projects for other Air Conditioning brands (Mitsubishi Electric, Mitsubishi Heavy Industries, Toshiba, LG, Sanyo...), ask us for details.

## 11.2 How to setup LonWorks' device address in IntesisBox and how to declare LonWorks devices as commissioned using LinkBoxEIB

LonWorks devices, as is the case of the DMS504B51 LON gateway for Daikin VRV systems, have a unique identifier called Neuron ID that is normally specified somewhere in the case or in the circuit board of the device, if you do not have the Neuron ID of your LonWorks device then you can get it using LinkBoxEIB.

Additionally, any LonWorks device must be commissioned to start working, this is normally done using any LonWorks standard commissioning tool such as LonMaker. In case your LonWorks device is not commissioned and you do not have any LonWorks standard commissioning tool to do it, then you can use also LinkBoxEIB and IntesisBox to do it in a single step, see the instructions below for details of both procedures.

Ensure following setup:

- Connect the IntesisBox at LonWorks TP/FT-10 bus
- Connect the IntesisBox PC console RS232 port to your PC
- Power-on IntesisBox

Now follow these steps:

1. Start LinkBox application in your PC, and select suitable project
2. Go to menu *Configuration->Connection...* to select suitable COM port for PC console, and save it.

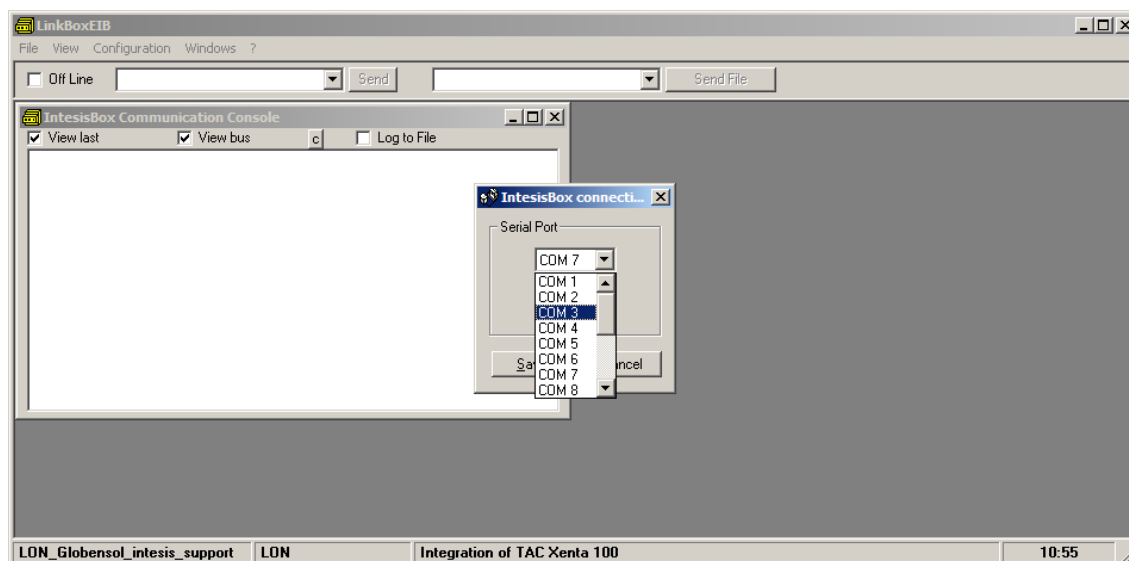

3. Click the checkbox next to *Offline* word below LinkBox Menu. It should change to *Online*, and some output must appear at *IntesisBox Communication Console* window.

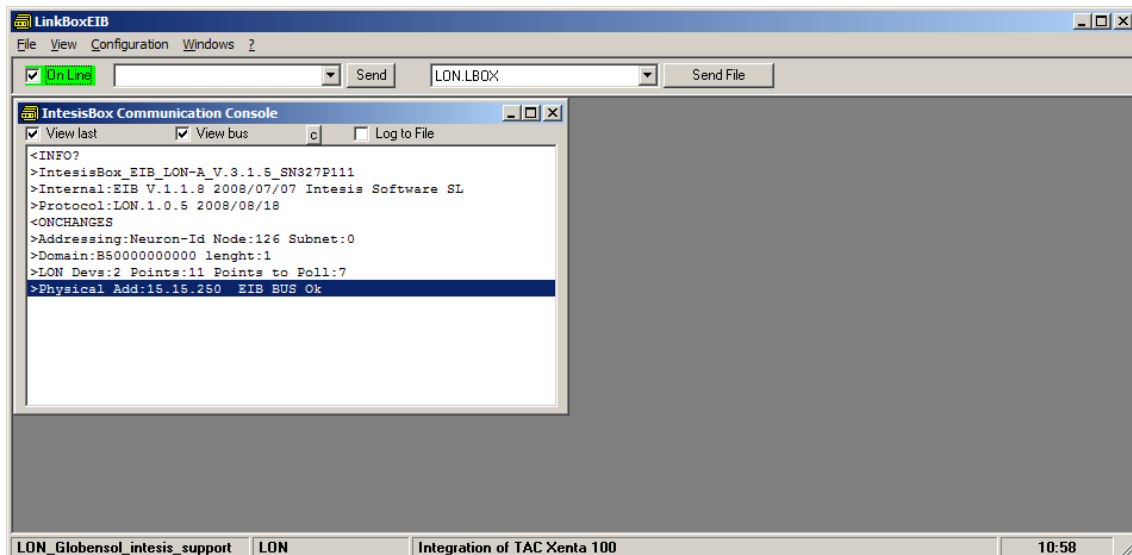

- The LonWorks device you are to connect should have a so-called "Service Pin Button" accessible. Press it. This will send a device identification message (*Service Pin Message*) to IntesisBox, which will be shown in IntesisBox Communication Console:

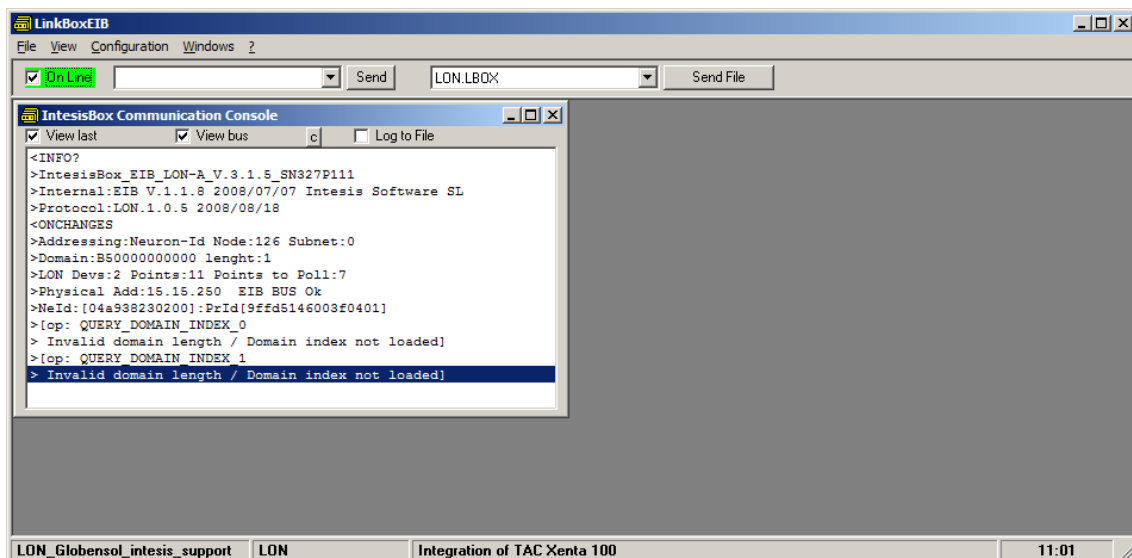

Output might differ depending on the configuration of the LonWorks device (i.e., if it has a configured domain or not).

- In this message, the tag *NeId:[xxxxxxxx]* poses as a unique identifier, in hexadecimal format (*Neuron Id*) for the LonWorks device we want to integrate. Note down this number, since we will need it in the configuration.

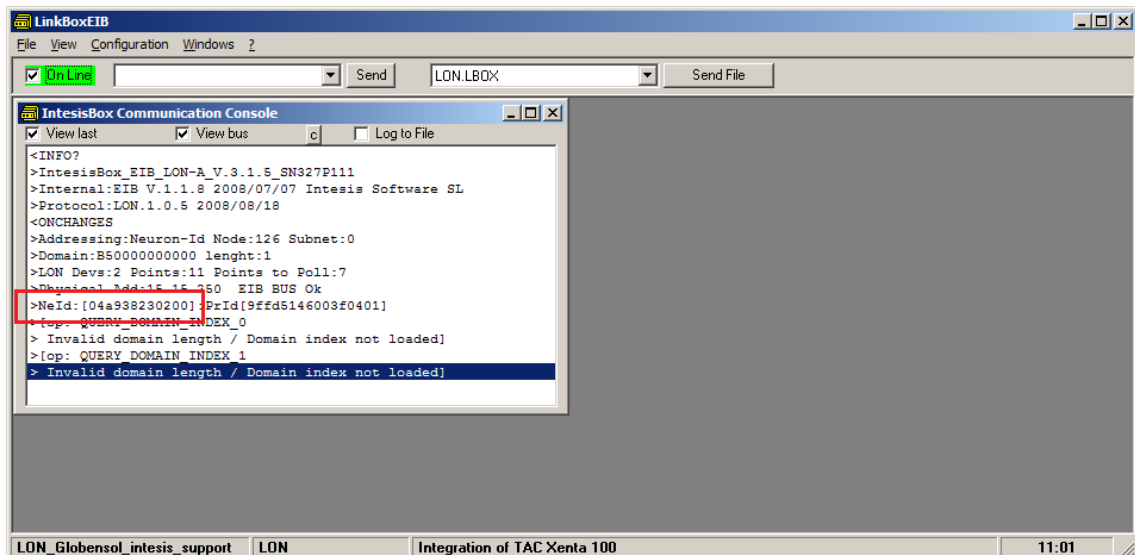

In the example above, Neuron Id is *04a938230200*

In order to load now this Neuron Id in project configuration, click *Configuration->IntesisBox..*

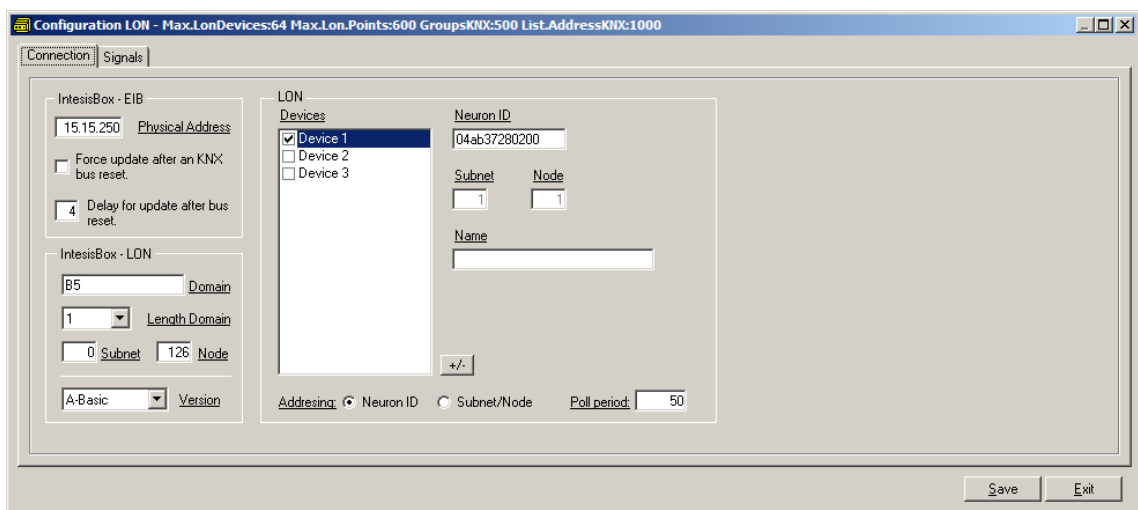

6. In it, ensure following settings for LonWorks:

- IntesisBox LON:
  - Domain: Any value is fine for this case. B5 is the factory value
  - Length domain: 1 is fine
  - Subnet: 0 is fine
  - Node: 126 is fine
- LON:
  - Select at the bottom of the square *Neuron-Id* as Addressing mode (default factory value)
  - Select Device 1 as the device for which the Neuron-Id is to be set.
  - Insert the Neuron-Id of the device, just as you noted it down

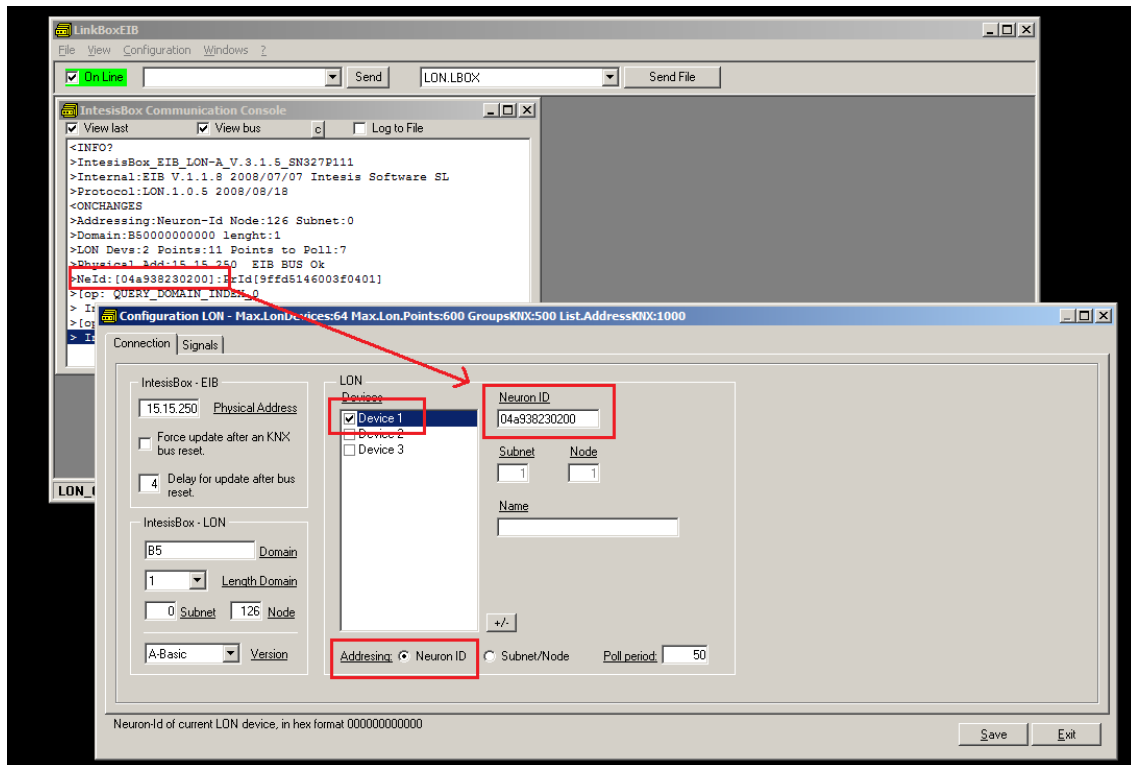

7. Click button Save and select Yes when asked if you want to save changes.
8. Once gateway configuration file is generated, click Send File in LinkBox main window

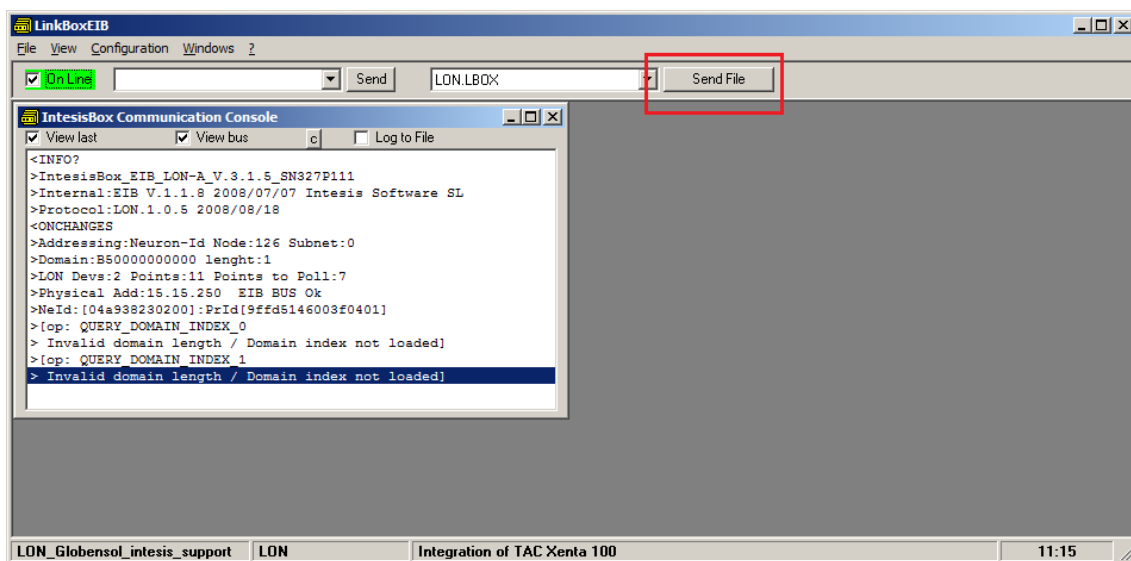

9. Once downloaded, we will check if communication at LonWorks side is properly working. Go to menu View->Bus->Lon. Something similar to this will appear:

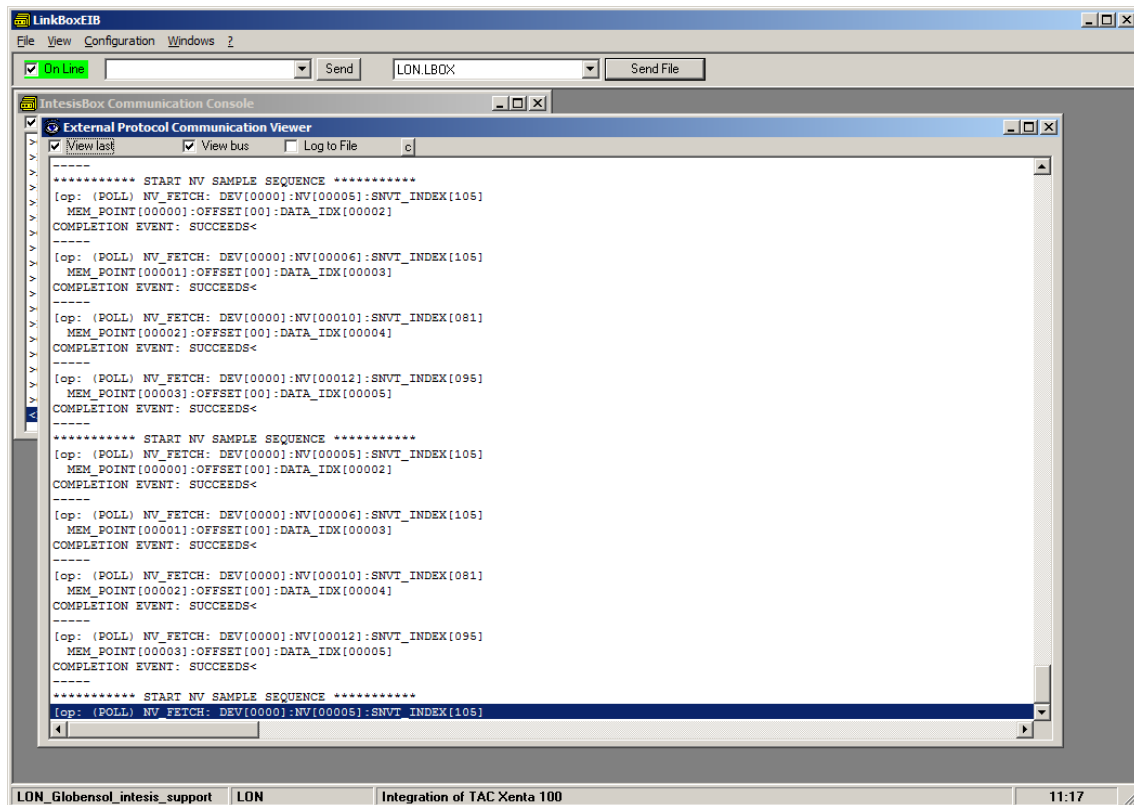

These pose as the query commands the IntesisBox is triggering to the LonWorks device being integrated.

Note that for each request (NV\_FETCH request) there is a response from the device, represented by the COMPLETION EVENT: SUCCEEDS< keywords.

- Finally, and solely in the case that your LonWorks device is placed in stand-alone (i.e. directly communicating with intesisBox and not integrated within a LonWorks network), you should declare the LonWorks device as commissioned. In order to do that, go to the textbox next to text "Online" below LinkBox menu, and type the command COMIT and press *Send*.

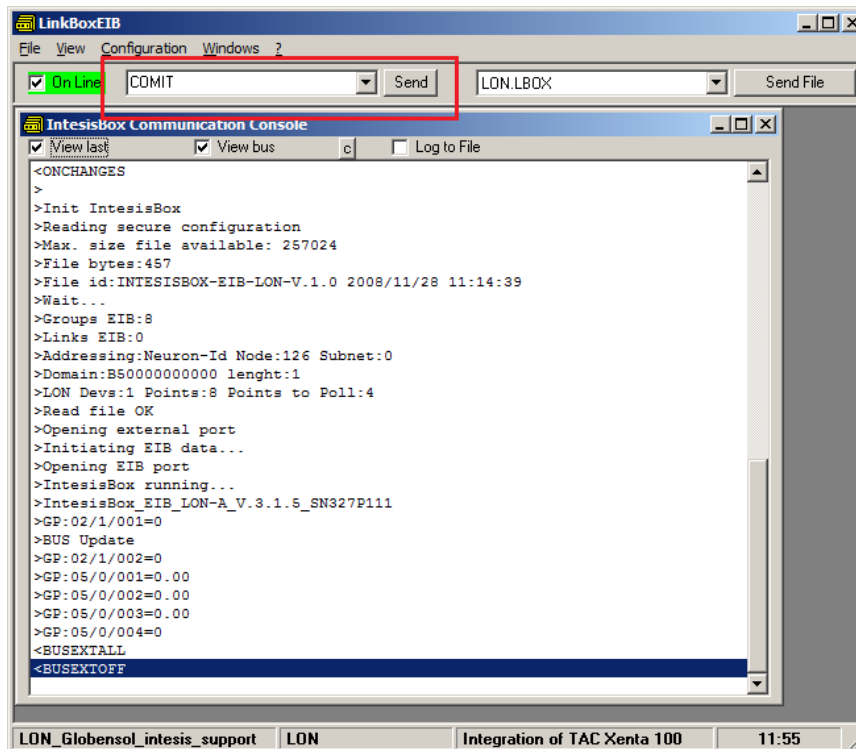

This will result in some text at IntesisBox Communication Console, similar to the one below:

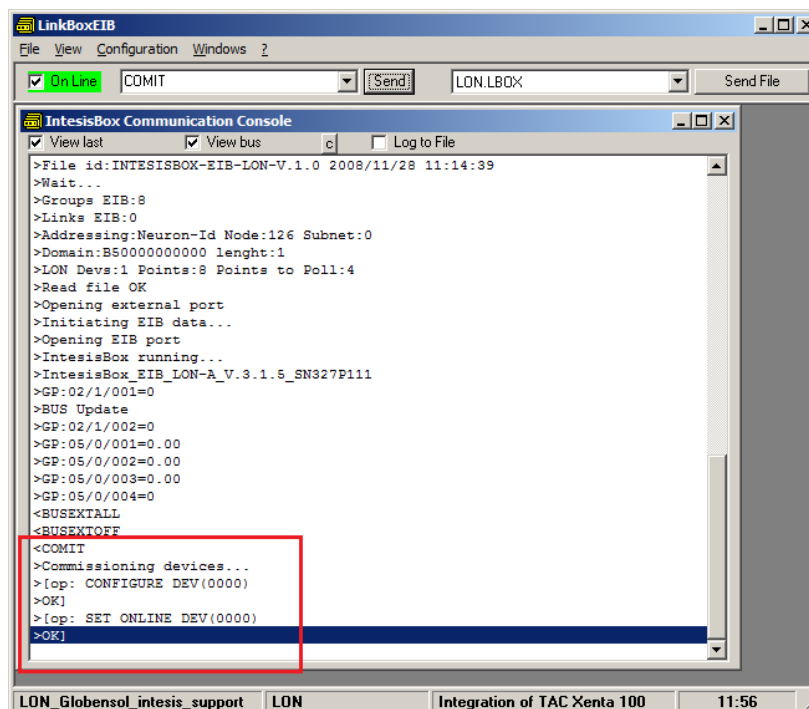

If all this process worked, now you are ready to communicate with your LonWorks device.